



INFORM SERIES

DKK PRICE LIST

01.01.2024



THE INFORM SERIES

Greet the users of the library with the clear design of the Inform series of counters, desks and search stations.

The Inform series is easily recognized due to its up to 40 mm thick panels, creating a continuous frame around the work space. The counter system is specially designed for library use and is both functional, expandable and allows to a great extent customization to your needs. Complement the counter with desks and search stations placed strategically around the library to create functional and user friendly work spaces for both the staff as well as the users of the library.

All three types of work spaces have a range of accessories available to create the right setting for all users.



The price list is valid from 01.01.2024 until 31.12.2024.

Conditions of sale and terms of delivery

All prices exclude VAT and delivery. Please see our conditions of sale and terms of delivery on our website.

Updating the price list

The price list will continually be updated and can be downloaded on our website. Please contact our sales office, who will forward a log-in and password via e-mail. We reserve the right to make product and price alterations without prior notice and accept no liability for printing errors.

DESIGN OPTIONS	4	COUNTER SHELVES	84
TECHNICAL SPECIFICATIONS	9	For rectangular counter	88
SEARCH STATION	10	For corner counter	89
DESKS	12	For 45° curved counter	90
COUNTER	18	For 90° curved counter	91
CONFIGURATION OPTIONS	19	DISPLAY AND STORAGE	92
STANDARD COUNTER	20	Corner display unit	93
Rectangular counter	22	Display cabinet with storage	95
45° curved counter	24	Display cabinet with drawers	97
90° curved counter	26	Display cabinet with shelves and shelving options	98
Rectangular counter (combination with recessed counter)	28	Display cabinet with book trolley	99
45° curved counter (combination with recessed counter)	30	Accessories for display cabinet	100
90° curved counter (combination with recessed counter)	32	FUNCTIONS	101
Connections	34	Bag shelves	103
Configurations	35	Counter top part with info sign	106
RECESSED COUNTER	36	Counter top part with bag shelf	108
Rectangular counter	38	Decorative board and info sign	111
45° curved counter	40	Functional accessories	113
90° curved counter	42	Power sockets	115
Rectangular counter (combination with standard counter)	44	FRONT PANEL OPTIONS	116
45° curved counter (combination with standard counter)	46	LED lighting	117
90° curved counter (combination with standard counter)	46	Graphics	119
Connections	50	DRILL HOLES FOR CABLE CONDUCT & RFID	120
Configurations	51		
STEP COUNTER	52		
Counter tops	54		
Front panels	55		
Middle panels	56		
Configurations	57		
CORNER COUNTER	58		
Square corner counter top and front panel	60		
Triangular corner counter top and front panel	61		
INFO TABLES	62		
Counter top with foot and side panel	64		
Counter top with panel and side panel	65		
HEIGHT ADJUSTABLE COUNTER	66		
Height adjustable rectangular counter	70		
H740 mm rectangular counter for height adjustable	72		
H740 mm 45° curved counter for height adjustable	74		
H740 mm 90° curved counter for height adjustable	76		
H740 mm 45° curved counter for height adjustable and recessed	78		
H740 mm 90° curved counter for height adjustable and recessed	79		
Square corner counter for height adjustable	80		
Triangular corner counter for height adjustable	81		
Middle panels	82		
Configurations	83		

DESIGN OPTIONS

STEEL COMPONENTS - PAINTED

A PRICE GROUP - BASIS PRICE (smooth finish)



A03
Traffic white
RAL 9016
Gloss 75-90



A02
Oyster white
RAL 1013
Gloss 40-50

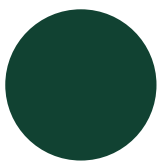

A22
Moss green
RAL 6005
Gloss 71-85



A26
Fir green
RAL 6009
Gloss 71-85

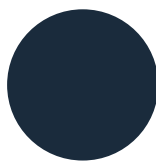

A12
Steel blue
RAL 5011
Gloss 71-85



A13
Light grey
RAL 7035
Gloss 71-85

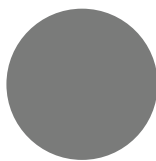

A15
Dusty grey
RAL 7037
Gloss 71-85

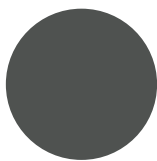

A16
Traffic grey
RAL 7043
Gloss 71-85

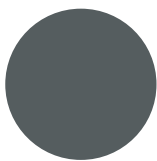

A17
Basalt grey
RAL 7012
Gloss 71-85

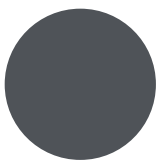

A18
Slate grey
RAL 7015
Gloss 71-85

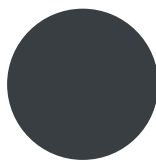

A19
Anthracite grey
RAL 7016
Gloss 71-85

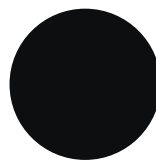

A25
Jet black
RAL 9005
Gloss 71-85

B PRICE GROUP - BASIS PRICE WITH 7% SURCHARGE (smooth finish)



A01
Pure white
RAL 9010
Gloss 71-85

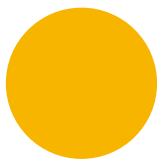

A04
Traffic yellow
RAL 1023
Gloss 71-85

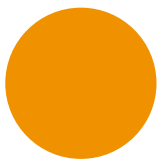

A05
Sun yellow
RAL 1037
Gloss 71-85

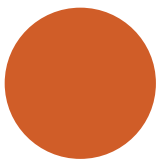

A06
Signal orange
RAL 2010
Gloss 71-85

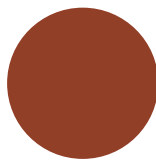

A07
Pearl orange
RAL 2013
Gloss 65-85

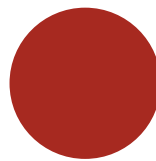

A08
Flame red
RAL 3000
Gloss 71-85



A09
Ruby red
RAL 3003
Gloss 71-85

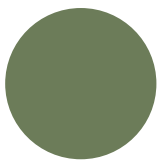

A21
Reseda green
RAL 6011
Gloss 71-85

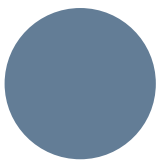

A10
Pigeon blue
RAL 5014
Gloss 71-85

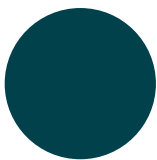

A11
Ocean blue
RAL 5020
Gloss 71-85

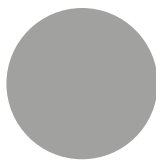

A14
White aluminium
RAL 9006
Gloss 50-70

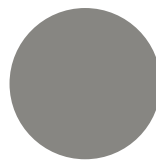

A31
Grey aluminium
RAL 9007
Gloss 50-70

B PRICE GROUP - BASIS PRICE WITH 7% SURCHARGE (textured finish)



A27
Pure white
RAL 9010

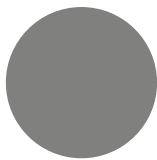

A29
Concertina grey

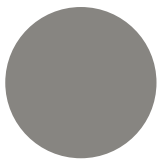

A28
Grey aluminium
RAL 9007

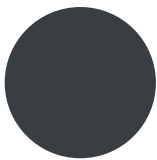

A23
Anthracite grey
RAL 7016

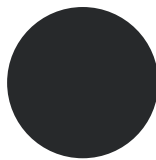

A24
Graphite black
RAL 9011

Note:

- Other RAL/NCS colours have a starter fee of GBP 215 / EUR 250 and a surcharge of 15%. A higher surcharge for colours with "metallic" look or different surface textures must be expected.
- See specific colour for steel gloss specification. Special requests outside specified gloss range are not covered by the above surcharges.

DESIGN OPTIONS

ACRYLIC COMPONENTS

A PRICE GROUP - BASIS PRICE

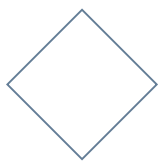

030
Crystal clear



046
Frost white



047
Arctic blue



048
Paprika red

Note:

- The acrylic front panels can be combined with acrylic side panels on shelving in the same colour. They can also be combined with lighting.

DESIGN OPTIONS

WOODEN COMPONENTS - MELAMINE/LAMINATE

A PRICE GROUP - BASIS PRICE

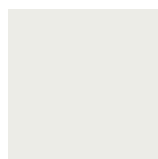

D61/L61
Signal white
RAL 9003



D72/L72
Oyster white
Similar to RAL 1013

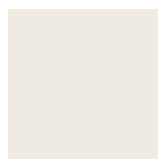

D62/L62
Pure white
Similar to RAL 9010



D63/L63
Steel blue
RAL 5011



D71/L71
Dusty grey
Similar to RAL 7037



D16/L16
Basalt grey
Similar to RAL 7012



D19/L19
Slate grey
Similar to RAL 7015 and
RAL 7016



D04/L04
Beech decor



D05/L05
Maple decor



D06/L06
Cherry decor



D07/L07
Oak decor



D08/L08
Olive decor

C PRICE GROUP - BASIS PRICE WITH 10% SURCHARGE



D64/L64
Signal yellow
RAL 1003



D65/L65
Yellow orange
RAL 2000



D66/L66
Pure orange
RAL 2004



D67/L67
Traffic red
RAL 3020



E02/L02
Ruby red
Similar to RAL 3003



D13/L13
Lime green
Similar to NCS S1060-G40Y



D68/L68
Reseda green
Similar to RAL 6011



D14/L14
Crystal blue
Similar to NCS S1020-R90B



D73/L73
Pigeon blue
RAL 5014



D74/L74
Ocean blue
Similar to RAL 5020



D69/L69
Light grey
Similar to RAL 7035



D70/L70
White aluminium
Similar to RAL 9006



D75/L75
Jet black
Similar to RAL 9005

Note:

- The above selection of colours are shown in both melamine (D/Exx) and laminate (Lxx).
- If you order a product (e.g. Inform Search station) in two different colours from price group C, then please note that you will be charged two times the surcharge - one for each colour.

DESIGN OPTIONS

WOODEN COMPONENTS - VENEER

A PRICE GROUP - BASIS PRICE



55
Light steamed
beech



66
Oak



67
Maple



68
Ash



69
Birch

Note:

- Table and work surfaces with solid wood veneer only have limited abrasion resistance. We recommend using HPL (which has a special overlay). For these types of surfaces, due to its higher durability against damages and scratches. Do not use veneer surfaces. If veneer is used for counter tops, we do not accept any complaints for damages or scratches.



TECHNICAL SPECIFICATIONS

STEEL COMPONENTS

are powder coated with standard polyester based powders that secures high UV resistance. Powders comply with EN 45545 (fire protection - similar to DIN 4201). Thickness of the coating is 60-80 my.

The powder used includes:

- no triglycidylisocyanurate (TGIC)
- no heavy metal-containing pigments such as lead and cadmium
- no volatiles

Antibacterial equipping of surfaces upon request.

LEG FRAMES

are made of steel section 40 x 40 x 2 mm and 40 x 20 x 2 mm and finished with a powder coat of thermo hardened polyester powder or epoxy (depending on choice of colour). Note: a leg frame is required per counter top in the same counter height.

WOODEN COMPONENTS

are either melamine coated, high pressure laminated (HPL) or have a environmental-friendly transparent lacquered veneer finish. Differences in colour underline the characteristics of veneer and cannot be avoided. They are conform to the norm EN 13986 of material type P2 and must only be used indoors. The border on each wooden panel is finished with an edge of melamine or with an edge of ABS (radius 2 mm). The edges are in the same colour of the wooden panels.

SEARCH STATION AND DESK

are produced in 40 mm particle board and have a melamine/veneer finish.

COUNTERS, SIDE- & MIDDLE PANELS, BAG SHELVES AND COUNTER SHELVES

are produced in 40 mm particle board and have a HPL finish.

WOODEN CABINETS, COUNTER TOP PARTS AND DECORATIVE BOARDS

are produced in 19 mm particle board and have a melamine/veneer finish.

STRAIGHT WOODEN FRONT PANELS FOR COUNTERS AND COUNTER SHELVES

are produced in 19 mm particle board and have a melamine/veneer finish.

CURVED WOODEN FRONT PANELS FOR COUNTERS AND COUNTER SHELVES

are produced in 19 mm particle board and have a HPL finish.

PLINTH

is produced in 19 mm particle board and has a melamin aluminum finish.

ACRYLIC COMPONENTS

ACRYLIC FRONT PANELS

are made of 5 mm acrylic glass panel, known as Plexiglas XT®. This material is conform with the EU norm EN 13501-1 (classification D like the German's norm DIN 4102-1)

LIGHTING

LIGHTING FOR COUNTER

You can add light under the counter with the use of an acrylic front panel. This light is only for use indoors and is conform with the norm 60598-1 ed 2000 + A 11 ed. 2000, EN 60598-2-1 Ed. 1998.

CLEANING

Clean wooden-, metal- and acrylic surfaces with a damp cloth and wipe dry with a clean cloth. Use a water based cleaning agent. DO NOT USE A DETERGENT!

INFORM SEARCH STATION

SINGLE- AND DOUBLE-SIDED



INFORM SEARCH STATION

SINGLE- AND DOUBLE-SIDED

Search station with offset keyboard and monitor levels. Place the CPU in the lockable cabinet with sufficient ventilation provided by the recoiling base and the air and cable conduct. Place freestanding monitor on the top level, alternately install a console for flat-screen monitors. The back wall/door can be ordered in different colours compared to the top/side panels.

Inform search station - single-sided

Exterior: W750 x D625 x H1065 mm

Interior: W670 x D260 x H740 mm

With choice of desk grommet.

Material	Colour	Item no. Melamine	Price DKK	Item no. Veneer	Price DKK
Plastic	Black	BI610126	9.195	BI616122	15.144
Plastic	Oyster white	BI610186	9.429	BI616182	15.466
Plastic	Silver	BI610196	9.429	BI616192	15.466
Metal	Stainless steel	BI610136	9.783	BI616132	15.949

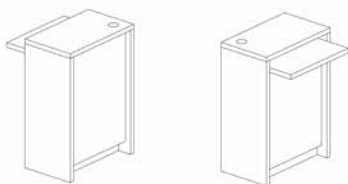

Inform search station - double-sided

Exterior: W750 x D1200 x H1065 mm

Interior: W670 x D610 x H740 mm

Material	Colour	Item no. Melamine	Price DKK	Item no. Veneer	Price DKK
Plastic	Black	BI610226	13.259	BI616222	21.838
Plastic	Oyster white	BI610286	13.494	BI616282	22.161
Plastic	Silver	BI610296	13.494	BI616292	22.161
Metal	Stainless steel	BI610236	13.846	BI616232	22.644



Console for flat-screen monitor

Lacquered steel. Incl. mounting kit.

Ideal for theft and tilt protection.

Item no.	Price DKK
B401418	1.997

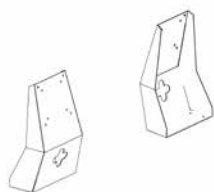

INFORM DESK

SOLO

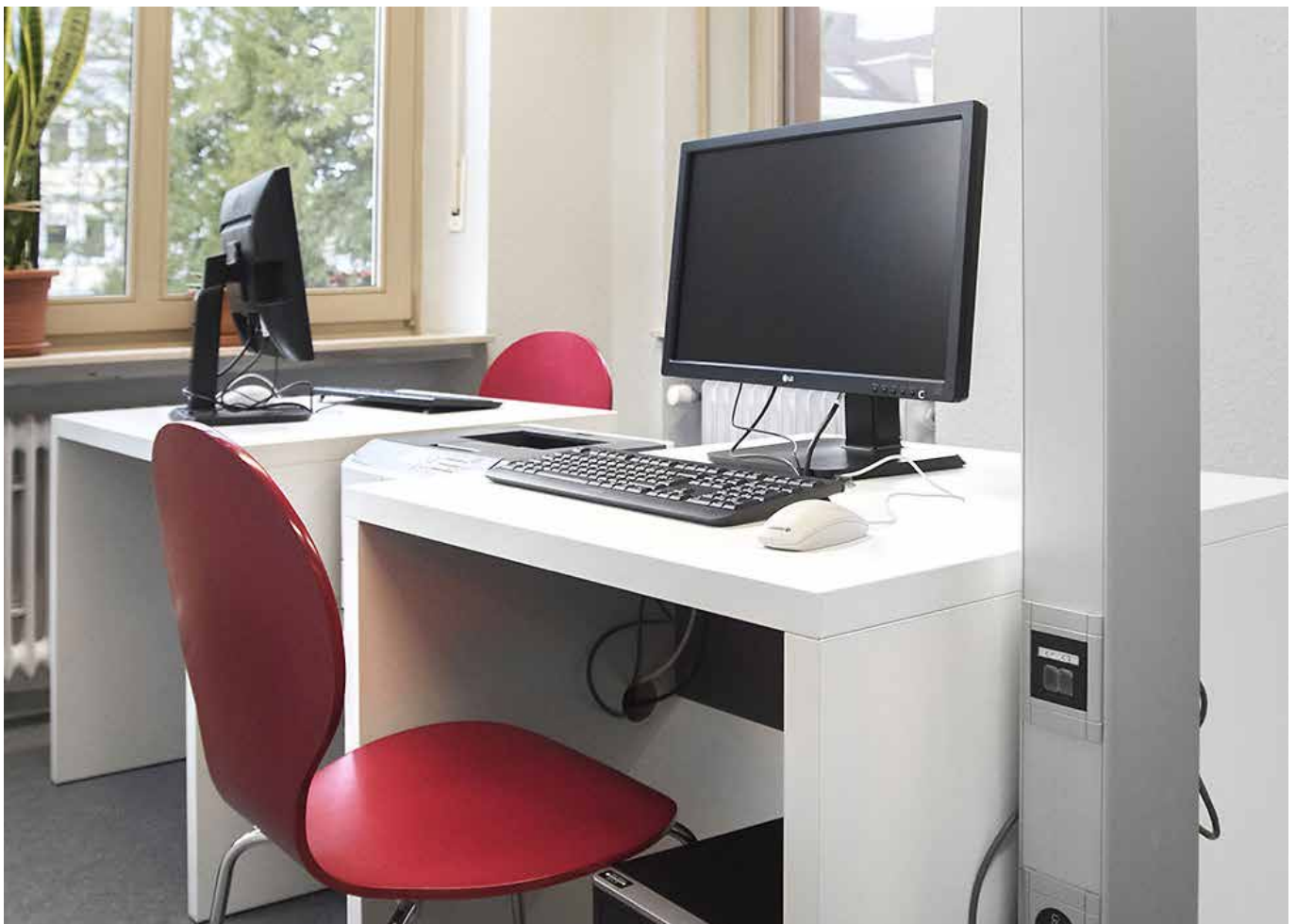

INFORM DESK

SOLO

Create a private workspace and work on your own with the Solo freestanding rectangular desk. For accessories, see page 113.

H740 mm - Rectangular table - freestanding - with panel (H305 mm) placed 50 mm from front

For counter with predrilled holes for cable conduct see pages 120-121.

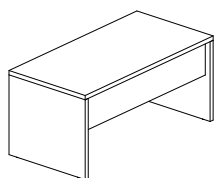

W x D mm	Item no. Melamine	Price DKK	Item no. Veneer	Price DKK
800 x 500	Bl620104006	5.506	Bl625104002	9.069
1000 x 500	Bl620114006	5.921	Bl625114002	9.753
1200 x 500	Bl620124006	6.339	Bl625124002	10.440
1400 x 500	Bl620134006	6.749	Bl625134002	11.116
1600 x 500	Bl620144006	7.175	Bl625144002	11.818
1800 x 500	Bl620154006	7.531	Bl625154002	12.404
800 x 600	Bl620204006	5.766	Bl625204002	9.497
1000 x 600	Bl620214006	6.197	Bl625214002	10.207
1200 x 600	Bl620224006	6.629	Bl625224002	10.918
1400 x 600	Bl620234006	7.057	Bl625234002	11.624
1600 x 600	Bl620244006	7.499	Bl625244002	12.351
1800 x 600	Bl620254006	7.997	Bl625254002	13.172
800 x 700	Bl620304006	6.058	Bl625304002	9.978
1000 x 700	Bl620314006	6.512	Bl625314002	10.726
1200 x 700	Bl620324006	6.960	Bl625324002	11.463
1400 x 700	Bl620334006	7.396	Bl625334002	12.183
1600 x 700	Bl620344006	7.865	Bl625344002	12.954
1800 x 700	Bl620354006	8.374	Bl625354002	13.793
800 x 800	Bl620404006	6.337	Bl625404002	10.437
1000 x 800	Bl620414006	6.799	Bl625414002	11.198
1200 x 800	Bl620424006	7.267	Bl625424002	11.970
1400 x 800	Bl620434006	7.727	Bl625434002	12.728
1600 x 800	Bl620444006	8.209	Bl625444002	13.521
1800 x 800	Bl620454006	8.738	Bl625454002	14.393

H1000 mm - Rectangular table - freestanding - with panel (H305 mm) placed 50 mm from front

For counter with predrilled holes for cable conduct see pages 120-121.

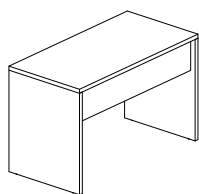

W x D mm	Item no. Melamine	Price DKK	Item no. Veneer	Price DKK
800 x 500	Bl620106006	6.062	Bl625106002	9.984
1000 x 500	Bl620116006	6.476	Bl625116002	10.667
1200 x 500	Bl620126006	6.893	Bl625126002	11.354
1400 x 500	Bl620136006	7.303	Bl625136002	12.029
1600 x 500	Bl620146006	7.731	Bl625146002	12.733
1800 x 500	Bl620156006	8.214	Bl625156002	13.530
800 x 600	Bl620206006	6.358	Bl625206002	10.472
1000 x 600	Bl620216006	6.789	Bl625216002	11.181
1200 x 600	Bl620226006	7.220	Bl625226002	11.892
1400 x 600	Bl620236006	7.648	Bl625236002	12.596
1600 x 600	Bl620246006	8.091	Bl625246002	13.327
1800 x 600	Bl620256006	8.588	Bl625256002	14.146
800 x 700	Bl620306006	6.690	Bl625306002	11.019
1000 x 700	Bl620316006	7.144	Bl625316002	11.767
1200 x 700	Bl620326006	7.591	Bl625326002	12.503
1400 x 700	Bl620336006	8.029	Bl625336002	13.224
1600 x 700	Bl620346006	8.497	Bl625346002	13.996
1800 x 700	Bl620356006	9.007	Bl625356002	14.835
800 x 800	Bl620406006	7.008	Bl625406002	11.543
1000 x 800	Bl620416006	7.471	Bl625416002	12.306
1200 x 800	Bl620426006	7.938	Bl625426002	13.074
1400 x 800	Bl620436006	8.400	Bl625436002	13.835
1600 x 800	Bl620446006	8.881	Bl625446002	14.627
1800 x 800	Bl620456006	9.411	Bl625456002	15.500

INFORM TABLE

DUO

Work opposite one another with the Duo freestanding, rectangular table. For accessories, see page 113.

H740 mm - Rectangular table - freestanding - with panel (H305 mm) in the centre of table top

For counter with predrilled holes for cable conduct see pages 120-121.

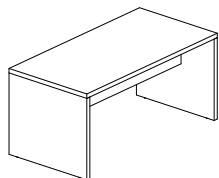

W x D mm	Item no. Melamine	Price DKK	Item no. Veneer	Price DKK
800 x 800	BI630404006	6.337	BI635404002	10.437
1000 x 800	BI630414006	6.799	BI635414002	11.198
1200 x 800	BI630424006	7.267	BI635424002	11.970
1400 x 800	BI630434006	7.727	BI635434002	12.728
1600 x 800	BI630444006	8.209	BI635444002	13.521
1800 x 800	BI630454006	8.738	BI635454002	14.393
800 x 1000	BI630504006	6.897	BI635504002	11.360
1000 x 1000	BI630514006	7.421	BI635514002	12.223
1200 x 1000	BI630524006	7.910	BI635524002	13.028
1400 x 1000	BI630534006	8.402	BI635534002	13.839
1600 x 1000	BI630544006	8.930	BI635544002	14.708
1800 x 1000	BI630554006	9.282	BI635554002	15.289
800 x 1200	BI630604006	7.711	BI635604002	12.701
1000 x 1200	BI630614006	8.155	BI635614002	13.432
1200 x 1200	BI630624006	8.943	BI635624002	14.730
1400 x 1200	BI630634006	9.371	BI635634002	15.434
1600 x 1200	BI630644006	9.807	BI635644002	16.153
1800 x 1200	BI630654006	10.433	BI635654002	17.185
800 x 1400	BI630704006	8.209	BI635704002	13.521
1000 x 1400	BI630714006	9.055	BI635714002	14.914
1200 x 1400	BI630724006	9.524	BI635724002	15.687
1400 x 1400	BI630734006	10.697	BI635734002	17.619
1600 x 1400	BI630744006	11.177	BI635744002	18.409
1800 x 1400	BI630754006	11.730	BI635754002	19.321
800 x 1600	BI630804006	8.704	BI635804002	14.337
1000 x 1600	BI630814006	9.594	BI635814002	15.802
1200 x 1600	BI630824006	10.104	BI635824002	16.643
1400 x 1600	BI630834006	11.318	BI635834002	18.642
1600 x 1600	BI630844006	11.838	BI635844002	19.498
1800 x 1600	BI630854006	12.434	BI635854002	20.480

INFORM TABLE

DUO

Work opposite one another with the Duo freestanding, rectangular table. For accessories, see page 113.

H1000 mm - Rectangular table - freestanding - with panel (H305 mm) in the centre of table top

For counter with predrilled holes for cable conduct see pages 120-121.

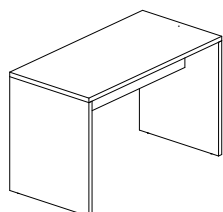

W x D mm	Item no. Melamine	Price DKK	Item no. Veneer	Price DKK
800 x 800	BI630406006	7.008	BI635406002	11.543
1000 x 800	BI630416006	7.471	BI635416002	12.306
1200 x 800	BI630426006	7.938	BI635426002	13.074
1400 x 800	BI630436006	8.400	BI635436002	13.835
1600 x 800	BI630446006	8.881	BI635446002	14.627
1800 x 800	BI630456006	9.411	BI635456002	15.500
800 x 1000	BI630506006	7.541	BI635506002	12.421
1000 x 1000	BI630516006	8.064	BI635516002	13.282
1200 x 1000	BI630526006	8.555	BI635526002	14.090
1400 x 1000	BI630536006	9.046	BI635536002	14.899
1600 x 1000	BI630546006	9.574	BI635546002	15.769
1800 x 1000	BI630556006	9.926	BI635556002	16.349
800 x 1200	BI630606006	8.391	BI635606002	13.820
1000 x 1200	BI630616006	8.834	BI635616002	14.551
1200 x 1200	BI630626006	9.624	BI635626002	15.851
1400 x 1200	BI630636006	10.049	BI635636002	16.552
1600 x 1200	BI630646006	10.487	BI635646002	17.273
1800 x 1200	BI630656006	11.113	BI635656002	18.304
800 x 1400	BI630706006	8.997	BI635706002	14.820
1000 x 1400	BI630716006	9.843	BI635716002	16.213
1200 x 1400	BI630726006	10.313	BI635726002	16.986
1400 x 1400	BI630736006	11.484	BI635736002	18.915
1600 x 1400	BI630746006	11.964	BI635746002	19.706
1800 x 1400	BI630756006	12.516	BI635756002	20.616
800 x 1600	BI630806006	9.827	BI635806002	16.186
1000 x 1600	BI630816006	10.713	BI635816002	17.646
1200 x 1600	BI630826006	11.225	BI635826002	18.488
1400 x 1600	BI630836006	12.439	BI635836002	20.489
1600 x 1600	BI630846006	12.959	BI635846002	21.345
1800 x 1600	BI630856006	13.555	BI635856002	22.326

INFORM TABLE

DUO & TWIN



INFORM TABLE

TWIN

Work or play? Create a fun and interesting - yet functional - sitting or standing area in the library with the Inform curved desk. For accessories, see page 113.

H740 mm - 2 x 90° curved tables - freestanding - with panel (H305 mm) in the centre of table top

Total length 3250 mm, total depth 1122 mm. For counter with predrilled holes for cable conduct see pages 120-121.

D mm	Item no. Melamine	Price DKK	Item no. Veneer	Price DKK
800	BI64044006	21.875	BI64544002	36.032

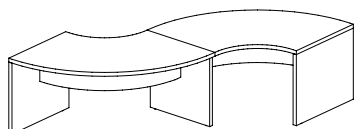

H1000 mm - 2 x 90° curved tables - freestanding - with panel (H305 mm) in the centre of table top

Total length 3250 mm, total depth 1122 mm. For counter with predrilled holes for cable conduct see pages 120-121.

D mm	Item no. Melamine	Price DKK	Item no. Veneer	Price DKK
800	BI64046006	22.682	BI64546002	37.359

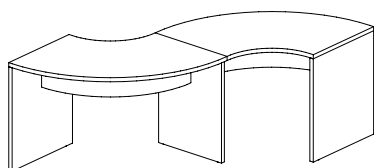

INFORM COUNTER

Inform is a modular piece of furniture. Straight and curved elements can be used as freestanding counters or randomly combined. The special design of the table tops and side panels creates a continuous surrounding frame which unites the single elements into an expressive optical unit.

Inform's modular construction allows an individual adaptation to functional and design requirements, as well as to architectural conditions. You are able to reconstruct and add on as well as electrically adjust the counter to your ideal working height. Modules in the two heights; 740 and 1000 mm can be combined in many ways. The counter is also suitable for use with RFID systems.

CONSTRUCTION

The construction of the counter Inform is based on a left-to-right sequence (seen from the person's view sitting behind the counter). The counter has 15 mm adjustable feet.

MOUNTING TOLERANCES

All our components for the Inform counter are produced according to the norm DIN ISO 2768-1.

ASSEMBLY

No special fittings or tools are needed.

DIMENSIONS

For planning purposes, please note the below measurements. The listed measurements in the catalogue/price list are the effective measurements for the front panels only. It is necessary to add 40 mm with all the side/end panels, step counter middle panels and middle panels in connection with height adjustable counters.

STARTER-, MIDDLE- & END ELEMENT

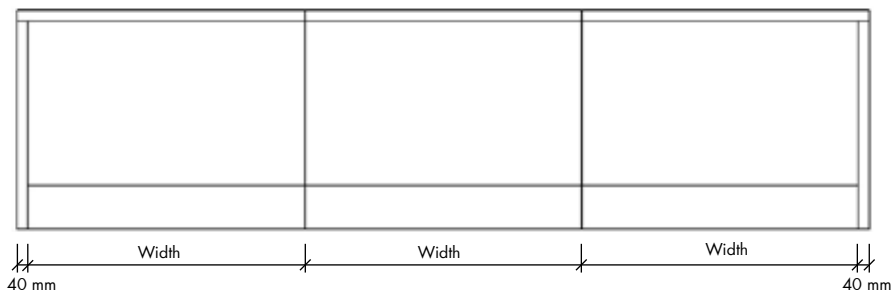

STEP COUNTER

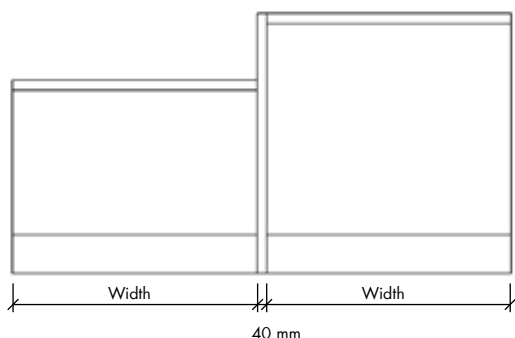

HEIGHT ADJUSTABLE COUNTER

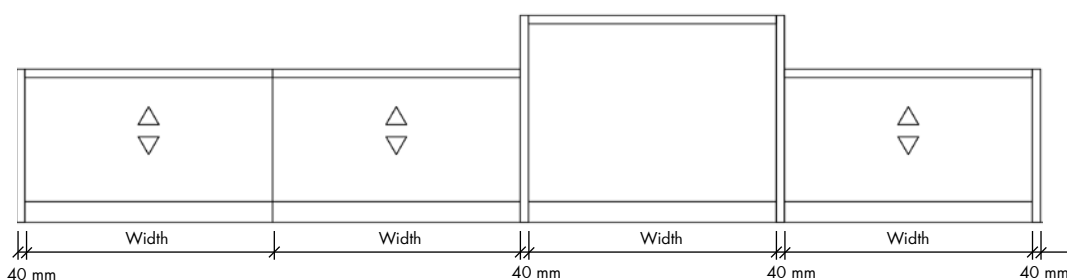

CONFIGURATION OPTIONS

RECTANGULAR COUNTERS

W 600/800/1000/1200/1400/1600 mm (+40 mm per outer panel)
 H 740/1000 mm
 D 800 mm

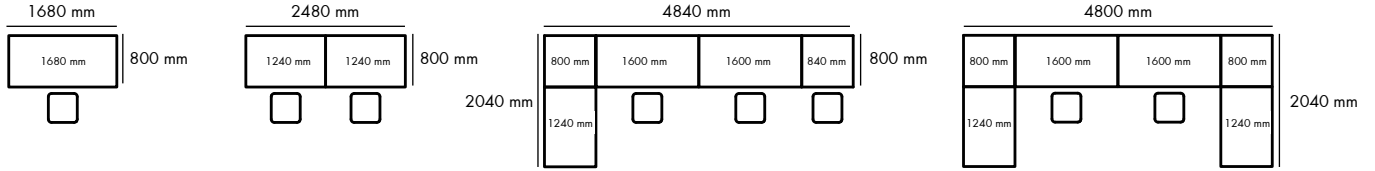

CURVED COUNTERS 45° & 90°

Height:	740 mm	Height:	740 mm
Inside radius:	1550 mm	Inside radius:	500 mm
Outer radius:	2350 mm	Outer radius:	1300 mm

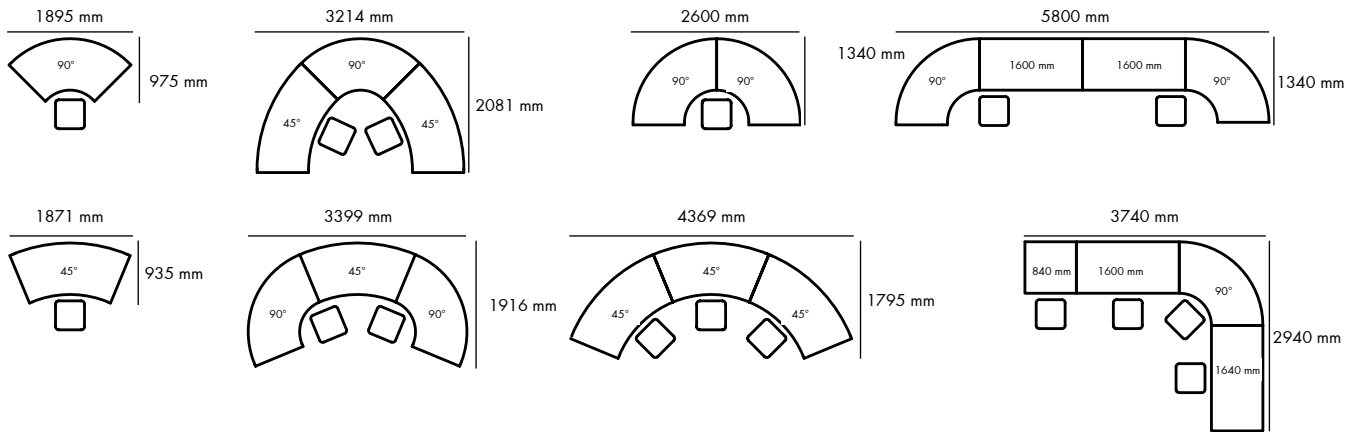

RECTANGULAR AND CURVED COUNTERS WITH VARIOUS INTEGRATED CABINETS/COUNTERS

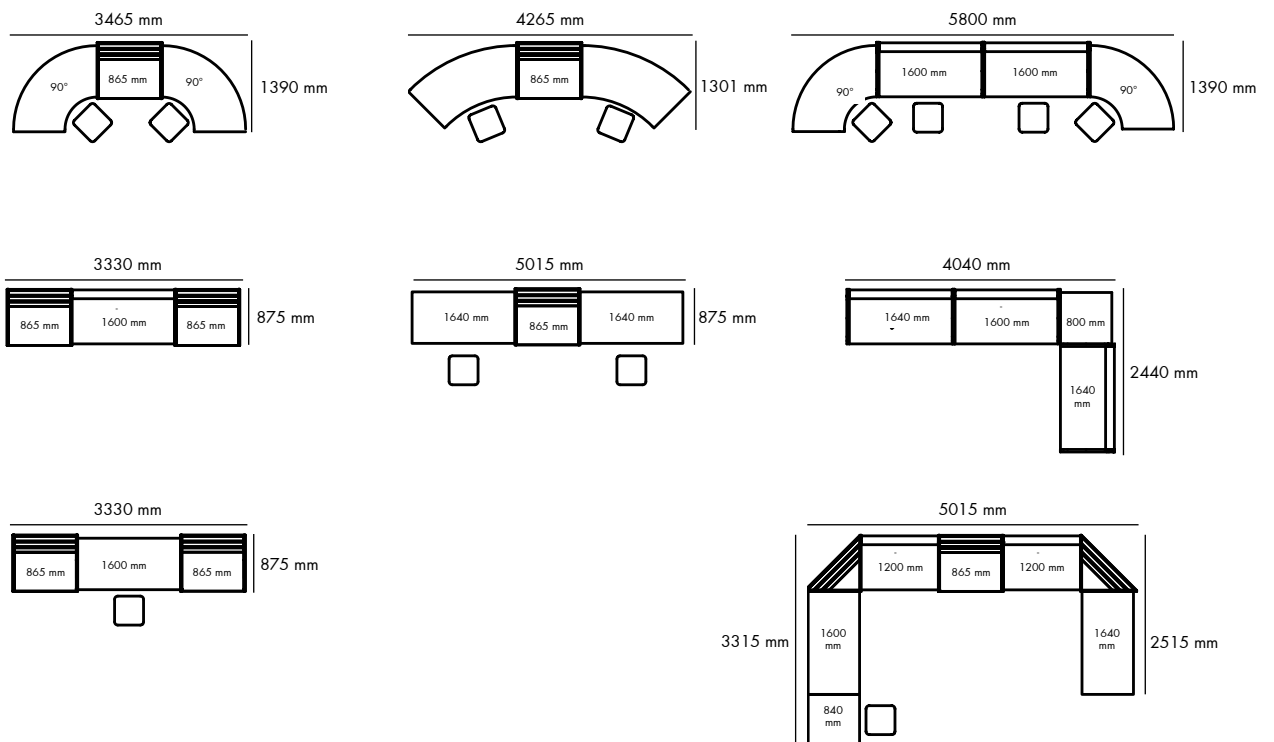

STANDARD COUNTER

CONFIGURATION NO. 1

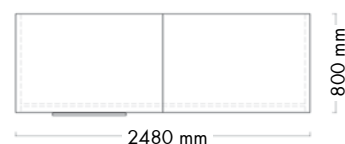

Rectangular counter (with info sign)

Components	Article no.	Price DKK	Quantity	DKK
Rectangular counter - starter (W1240 x H740 mm)	BI2001022003	5.995,00	1	5.995
Rectangular counter - end (W1240 x H740 mm)	BI2003022003	5.995,00	1	5.995
Wooden front panel for rectangular counter (W1200 x H740 mm)	BI300546	2.368,00	2	4.736
Steel leg frame (H740 mm)	BI069146	2.855,00	1	2.855
Info sign - acrylic frosted white glazed (W600 x H430 mm)	BI85512	2.533,00	1	2.533
Monitor arm	B401184	6.354,00	1	6.354
Total price for configuration				28.468

Comments to configuration

- Monitor, office chair and text are not included in price.
- All prices are based on colours and surfaces in price group A, see pages 4-7 for colours.
- We recommend the use of desk grommets, cable rails and drawer pedestals with the Inform counter, see page 113.
- It is necessary to drill an Ø80 mm hole for the monitor arm on site or modify the article number for counter for predrilled hole, see pages 120-121.

STANDARD COUNTER

CONFIGURATION NO. 2

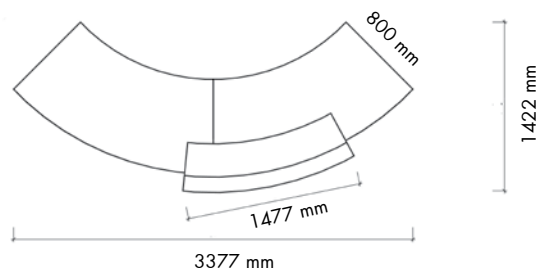

45° curved counters (with counter top part with bag shelf)

Components	Article no.	Price DKK	Quantity	DKK
45° curved counter - starter (H740 mm)	BI2051428003	9.243,00	1	9.243
45° curved counter - end (H740 mm)	BI2053428003	9.243,00	1	9.243
Wooden front panel for 45° curved counter (H740 mm)	BI3204543	15.820,00	2	31.640
Steel leg frame (H740 mm)	BI069146	2.855,00	1	2.855
Wooden counter top part with bag shelf (W1400 x H490 mm)	BI83545683	13.225,00	1	13.225
Total price for configuration				66.206

Comments to configuration

- Computer, office chair and text are not included in price.
- All prices are based on colours and surfaces in price group A, see pages 4-7 for colours.
- We recommend the use of desk grommets, cable rails and drawer pedestals with the Inform counter, see page 113.

STANDARD COUNTER

RECTANGULAR COUNTER

Inform's rectangular modules are available in two heights; 740 and 1000 mm. This model can be combined with other standard counters of the same height, step counters, height adjustable counters (only with H1000 mm standard counter), info counters, corner counters as well as display cabinets.

Rectangular counter - starter

Remember to order front panel, see page 23 and leg frame/middle panel, see page 34. For counter with predrilled holes for cable conduct see pages 120-121.

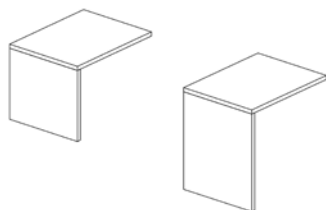

H x W x D mm	Item no. HPL	Price DKK
740 640 800	BI2001016003	5.093
740 840 800	BI2001018003	5.273
740 1040 800	BI2001020003	5.634
740 1240 800	BI2001022003	5.995
740 1440 800	BI2001024003	6.444
740 1640 800	BI2001026003	6.716
1000 640 800	BI2001036003	5.444
1000 840 800	BI2001038003	5.624
1000 1040 800	BI2001040003	5.985
1000 1240 800	BI2001042003	6.346
1000 1440 800	BI2001044003	6.796
1000 1640 800	BI2001046003	7.067

Rectangular counter - middle

Remember to order front panel, see page 23 and leg frame/middle panel, see page 34. For counter with predrilled holes for cable conduct see pages 120-121.

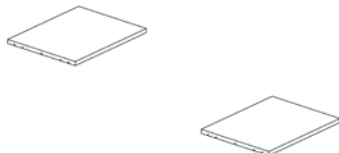

W x D mm	Item no. HPL	Price DKK
600 800	BI2002060003	2.836
800 800	BI2002080003	3.178
1000 800	BI2002081003	3.379
1200 800	BI2002082003	3.740
1400 800	BI2002084003	4.195
1600 800	BI2002086003	4.460

Rectangular counter - end

Remember to order front panel, see page 23 and leg frame/middle panel, see page 34. For counter with predrilled holes for cable conduct see pages 120-121.

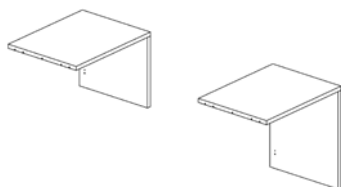

H x W x D mm	Item no. HPL	Price DKK
740 640 800	BI2003016003	5.093
740 840 800	BI2003018003	5.273
740 1040 800	BI2003020003	5.634
740 1240 800	BI2003022003	5.995
740 1440 800	BI2003024003	6.444
740 1640 800	BI2003026003	6.716
1000 640 800	BI2003036003	5.444
1000 840 800	BI2003038003	5.624
1000 1040 800	BI2003040003	5.985
1000 1240 800	BI2003042003	6.346
1000 1440 800	BI2003044003	6.796
1000 1640 800	BI2003046003	7.067

STANDARD COUNTER

FREESTANDING RECTANGULAR COUNTER AND FRONT PANELS

A freestanding rectangular counter is an ideal solution for small rooms and is available in two heights; 740 and 1000 mm. Remember to order front panels.

Rectangular counter - freestanding

Remember to order front panel. For counter with predrilled holes for cable conduct see pages 120-121.

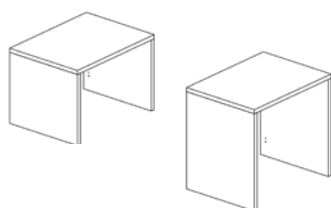

H x W x D mm	Item no. HPL	Price DKK
740 680 800	BI2004016003	7.530
740 880 800	BI2004018003	7.709
740 1080 800	BI2004020003	8.070
740 1280 800	BI2004022003	8.430
740 1480 800	BI2004024003	8.881
740 1680 800	BI2004026003	9.153
1000 680 800	BI2004036003	8.231
1000 880 800	BI2004038003	8.411
1000 1080 800	BI2004040003	8.772
1000 1280 800	BI2004042003	9.133
1000 1480 800	BI2004044003	9.583
1000 1680 800	BI2004046003	9.853

Wooden front panel for rectangular counter

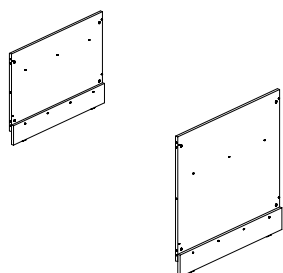

H x W mm	Item no. Melamine	Price DKK	Item no. Veneer	Price DKK
740 600	BI300146	1.543	BI300142	2.541
740 800	BI300346	1.773	BI300342	2.924
740 1000	BI300446	2.135	BI300442	3.517
740 1200	BI300546	2.368	BI300542	3.900
740 1400	BI300646	2.623	BI300642	4.318
740 1600	BI300746	3.020	BI300742	4.972
1000 600	BI300166	2.708	BI300162	4.460
1000 800	BI300366	2.761	BI300362	4.547
1000 1000	BI300466	3.547	BI300462	5.840
1000 1200	BI300566	3.661	BI300562	6.031
1000 1400	BI300666	3.697	BI300662	6.092
1000 1600	BI300766	3.734	BI300762	6.150

Acrylic front panel for rectangular counter

Melamine coated wooden frame.

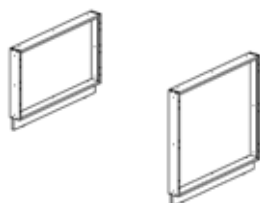

H x W mm	Item no. Acrylic & melamine	Price DKK
740 600	BI310146	5.790
740 800	BI310346	5.962
740 1000	BI310446	6.667
740 1200	BI310546	7.016
740 1400	BI310646	7.542
740 1600	BI310746	8.054
1000 600	BI310166	6.734
1000 800	BI310366	6.912
1000 1000	BI310466	7.613
1000 1200	BI310566	7.963
1000 1400	BI310666	8.489
1000 1600	BI310766	9.000

STANDARD COUNTER

45° CURVED COUNTERS

Inform's 45° curved modules are available in two heights; 740 and 1000 mm. This model can be combined with other standard counters of the same height, step counters, height adjustable counters (only with H1000 mm standard counter), info counters, corner counters as well as display cabinets.

45° curved counter - starter

Remember to order front panel, see page 25 and leg frame/middle panel, see page 34. For counter with predrilled holes for cable conduct see pages 120-121.

H	x	W	x	D
mm				
740	1835	800		
1000	1835	800		

Item no. HPL	Price DKK
BI2051428003	9.243
BI2051448003	9.595

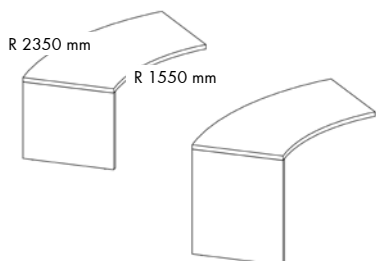

45° curved counter - middle

Remember to order front panel, see page 25 and leg frame/middle panel, see page 34. For counter with predrilled holes for cable conduct see pages 120-121.

W	x	D
mm		
1800	800	

Item no. HPL	Price DKK
BI2052488003	6.808



45° curved counter - end

Remember to order front panel, see page 25 and leg frame/middle panel, see page 34. For counter with predrilled holes for cable conduct see pages 120-121.

H	x	W	x	D
mm				
740	1835	800		
1000	1835	800		

Item no. HPL	Price DKK
BI2053428003	9.243
BI2053448003	9.595

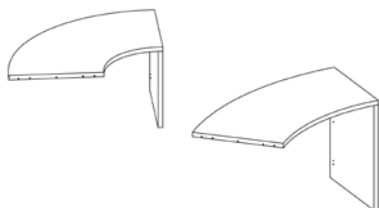

STANDARD COUNTER

FREESTANDING 45° CURVED COUNTERS AND FRONT PANELS

A freestanding 45° curved counter is an ideal solution for small rooms and is available in two heights; 740 and 1000 mm. Remember to order front panels.

45° curved counter - freestanding

Remember to order front panel. For counter with predrilled holes for cable conduct see pages 120-121.

H x W x D mm	Item no. HPL	Price DKK
740 1870 800	BI2054428003	11.679
1000 1870 800	BI2054448003	12.381

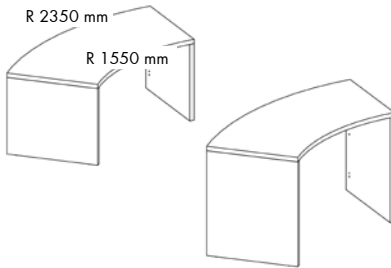

Wooden front panel for 45° curved counter

H x W mm	Item no. HPL	Price DKK
740 1760	BI3204543	15.820
1000 1760	BI3204563	18.503

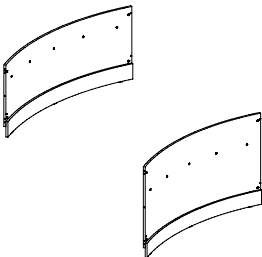

Acrylic front panel for 45° curved counter

Melaminecoated wooden frame.

H x W mm	Item no. Acrylic & melamine	Price DKK
740 1760	BI3304546	11.351
1000 1760	BI3304566	12.118

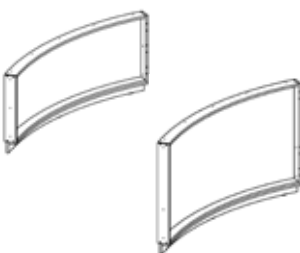

STANDARD COUNTER

90° CURVED COUNTERS

Inform's 90° curved modules are available in two heights; 740 and 1000 mm. This model can be combined with other standard counters of the same height, step counters, height adjustable counters (only with H1000 mm standard counter), info counters, corner counters as well as display cabinets.

90° curved counter - starter

Remember to order front panel, see page 27 and leg frame/middle panel, see page 34. For counter with predrilled holes for cable conduct see pages 120-121.

H	x	W	x	D
mm				
740	1870	800		
1000	1870	800		

Item no. HPL	Price DKK
BI2051928003	9.966
BI2051948003	10.317

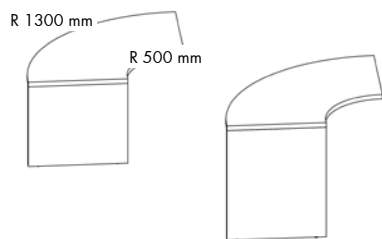

90° curved counter - middle

Remember to order front panel, see page 27 and leg frame/middle panel, see page 34. For counter with predrilled holes for cable conduct see pages 120-121.

W	x	D
mm		
1800	800	

Item no. HPL	Price DKK
BI2052988003	7.531



90° curved counter - end

Remember to order front panel, see page 27 and leg frame/middle panel, see page 34. For counter with predrilled holes for cable conduct see pages 120-121.

H	x	W	x	D
mm				
740	1870	800		
1000	1870	800		

Item no. HPL	Price DKK
BI2053928003	9.966
BI2053948003	10.317

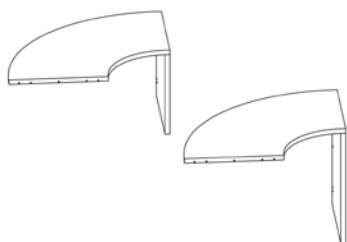

STANDARD COUNTERS

FREESTANDING 90° CURVED COUNTERS AND FRONT PANELS

A freestanding 90° curved counter is an ideal solution for small rooms and is available in two heights; 740 and 1000 mm. Remember to order front panels.

90° curved counter - freestanding

Remember to order front panel. For counter with predrilled holes for cable conduct see pages 120-121.

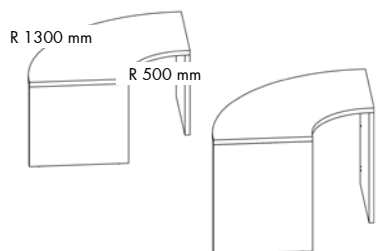

H x W x D mm	Item no. HPL	Price DKK
740 1900 800	BI2054928003	12.403
1000 1900 800	BI2054948003	13.103

Wooden front panel for 90° curved counter

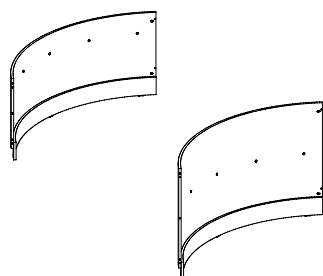

H x W mm	Item no. HPL	Price DKK
740 1768	BI3209043	16.087
1000 1768	BI3209063	16.806

Acrylic front panel for 90° curved counter

Melaminecoated wooden frame.

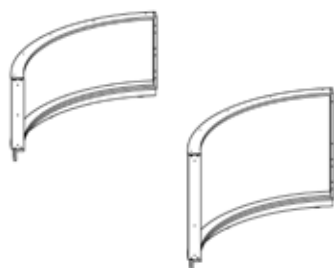

H x W mm	Item no. Acrylic & melamine	Price DKK
740 1768	BI3309046	14.645
1000 1768	BI3309066	15.594

STANDARD COUNTER

RECTANGULAR COUNTERS - FOR CONNECTING TO RECESSED COUNTER

Inform's rectangular modules are available in two heights; 740 and 1000 mm. This model can be combined with recessed counters of the same height as the standard counter by connecting with a middle panel (as the counter top is 40 mm wider than the standard rectangular counter).

Rectangular counter - starter - connected with middle panel

Remember to order front panel, see page 29 and middle panel, see page 34. For counter with predrilled holes for cable conduct see pages 120-121.

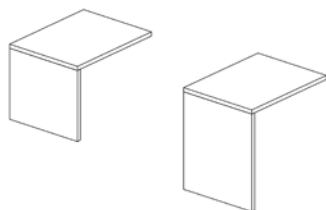

H x W x D mm	Item no. HPL	Price DKK
740 680 800	BI2021016003	5.093
740 880 800	BI2021018003	5.273
740 1080 800	BI2021020003	5.634
740 1280 800	BI2021022003	5.995
740 1480 800	BI2021024003	6.444
740 1680 800	BI2021026003	6.716
1000 680 800	BI2021036003	5.444
1000 880 800	BI2021038003	5.624
1000 1080 800	BI2021040003	5.985
1000 1280 800	BI2021042003	6.346
1000 1480 800	BI2021044003	6.796
1000 1680 800	BI2021046003	7.067

Rectangular counter - middle - connected with middle panel

Remember to order front panel, see page 29 and middle panel, see page 34. For counter with predrilled holes for cable conduct see pages 120-121.

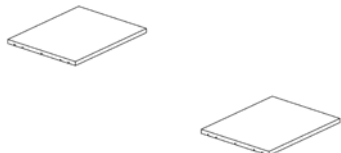

W x D mm	Item no. HPL	Price DKK
640 800	BI2022060003	2.836
840 800	BI2022080003	3.178
1040 800	BI2022081003	3.379
1240 800	BI2022082003	3.740
1440 800	BI2022084003	4.195
1640 800	BI2022086003	4.460

Rectangular counter - end - connected with middle panel

Remember to order front panel, see page 29 and middle panel, see page 34. For counter with predrilled holes for cable conduct see pages 120-121.

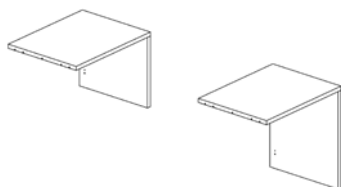

H x W x D mm	Item no. HPL	Price DKK
740 680 800	BI2023016003	5.093
740 880 800	BI2023018003	5.273
740 1080 800	BI2023020003	5.634
740 1280 800	BI2023022003	5.995
740 1480 800	BI2023024003	6.444
740 1680 800	BI2023026003	6.716
1000 680 800	BI2023036003	5.444
1000 880 800	BI2023038003	5.624
1000 1080 800	BI2023040003	5.985
1000 1280 800	BI2023042003	6.346
1000 1480 800	BI2023044003	6.796
1000 1680 800	BI2023046003	7.067

STANDARD COUNTER

RECTANGULAR FRONT PANELS

Remember to order front panels.

Wooden front panel for rectangular counter

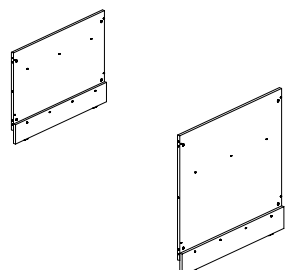
	H x W mm	Item no.		Price	
		Melamine	Veneer	DKK	DKK
	740 600	BI300146	BI300142	1.543	2.541
	740 800	BI300346	BI300342	1.773	2.924
	740 1000	BI300446	BI300442	2.135	3.517
	740 1200	BI300546	BI300542	2.368	3.900
	740 1400	BI300646	BI300642	2.623	4.318
	740 1600	BI300746	BI300742	3.020	4.972
	1000 600	BI300166	BI300162	2.708	4.460
	1000 800	BI300366	BI300362	2.761	4.547
	1000 1000	BI300466	BI300462	3.547	5.840
	1000 1200	BI300566	BI300562	3.661	6.031
1000 1400	BI300666	BI300662	3.697	6.092	
1000 1600	BI300766	BI300762	3.734	6.150	

Acrylic front panel for rectangular counter

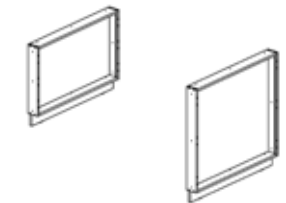
Melaminecoated wooden frame.	H x W mm	Item no. Acrylic & Melamine	Price DKK
	740 600	BI310146	5.790
	740 800	BI310346	5.962
	740 1000	BI310446	6.667
	740 1200	BI310546	7.016
	740 1400	BI310646	7.542
	740 1600	BI310746	8.054
	1000 600	BI310166	6.734
	1000 800	BI310366	6.912
	1000 1000	BI310466	7.613
	1000 1200	BI310566	7.963
1000 1400	BI310666	8.489	
1000 1600	BI310766	9.000	

STANDARD COUNTER

45° CURVED COUNTERS - FOR CONNECTING TO RECESSED COUNTER

Inform's° curved modules are available in two heights; 740 and 1000 mm. This model can be combined with recessed counters of the same height as the standard counter by connecting with a middle panel (as the counter top is 40 mm wider than the standard 45° curved counter).

45° curved counter - starter - connected with middle panel

Remember to order front panel, see page 31 and middle panel, see page 34. For counter with predrilled holes for cable conduct see pages 120-121.

H	x	W	x	D
mm				
740	-	800		
1000	-	800		

Item no. HPL	Price DKK
BI2061428003	9.243
BI2061448003	9.595

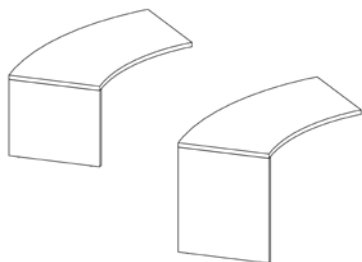

45° curved counter - end - for middle panel

Remember to order front panel, see page 31 and middle panel, see page 34. For counter with predrilled holes for cable conduct see pages 120-121.

H	x	W	x	D
mm				
740	-	800		
1000	-	800		

Item no. HPL	Price DKK
BI2063428003	9.243
BI2063448003	9.595

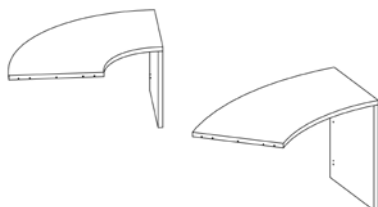

STANDARD COUNTER

45° CURVED FRONT PANELS

Remember to order front panels.

Wooden front panel for 45° curved counter

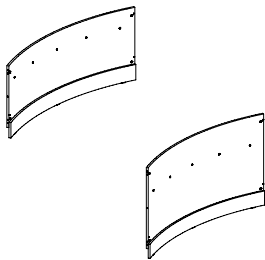

H	x	W
mm		
740	x	1760
1000	x	1760

Item no.	Price
HPL	DKK
BI3204543	15.820
BI3204563	18.503

Acrylic front panel for 45° curved counter

Melaminecoated wooden frame.

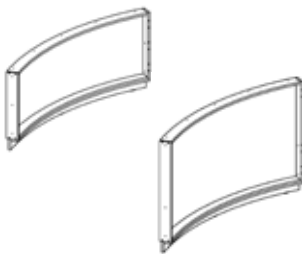

H	x	W
mm		
740	x	1760
1000	x	1760

Item no.	Price
Acrylic & melamine	DKK
BI3304546	11.351
BI3304566	12.118

STANDARD COUNTER

90° CURVED COUNTERS - FOR CONNECTING TO RECESSED COUNTER

Inform's 90° curved modules are available in two heights; 740 and 1000 mm. This model can be combined with recessed counters of the same height as the standard counter by connecting with a middle panel (as the counter top is 40 mm wider than the standard 90° curved counter).

90° curved counter - starter - connected with middle panel

Remember to order front panel, see page 33 and middle panel, see page 34. For counter with predrilled holes for cable conduct see pages 120-121.

H	x	W	x	D
mm				
740	-	800		
1000	-	800		

Item no. HPL	Price DKK
BI2061928003	9.966
BI2061948003	10.317

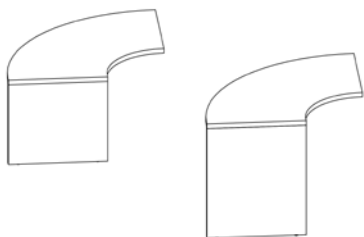

90° curved counter - end - connected with middle panel

Remember to order front panel, see page 33 and middle panel, see page 34. For counter with predrilled holes for cable conduct see pages 120-121.

H	x	W	x	D
mm				
740	-	800		
1000	-	800		

Item no. HPL	Price DKK
BI2063928003	9.966
BI2063948003	10.317

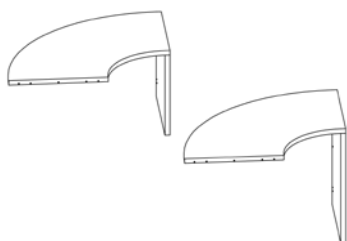

STANDARD COUNTERS



90° CURVED FRONT PANELS

Remember to order front panels.

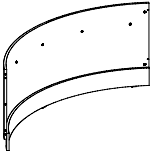
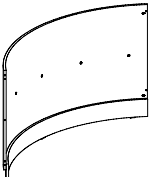
Wooden front panel for 90° curved counter

	H x W mm	Item no. HPL	Price DKK
	740 1768	BI3209043	16.087
	1000 1768	BI3209063	16.806

Acrylic front panel for 90° curved counter

Melaminecoated wooden frame.	H x W mm	Item no. Acrylic & melamine	Price DKK
	740 1768	BI3309046	14.645
	1000 1768	BI3309066	15.594

STANDARD COUNTER

CONNECTIONS

If you wish to combine a rectangular/curved counter with a rectangular/curved counter of the same height, you must use a steel leg frame.

If you wish to combine a rectangular/curved counter with recessed rectangular/curved or step counter, you must use a middle panel.

Steel leg frame

Must be used when assembling 2 modules of the same height.

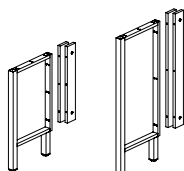

Finish	H mm	Item no. Melamine/veneer	Price DKK
Melamine	740	BI069146	2.855
	1000	BI069166	3.184
Veneer	740	BI069142	4.702
	1000	BI069162	5.244

Middle panel for standard and recessed counter

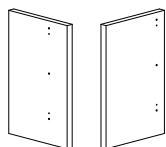

Side of panel	H mm	Item no. HPL	Price DKK
Left : Recessed counter Right: Standard counter	740	BI3704103	1.281

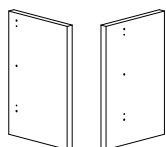

Left: Standard counter Right: Recessed counter	740	BI3704113	1.281
---	-----	-----------	-------

Middle panel for standard and step counter

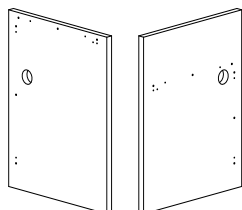

Side of panel	H mm	Item no. HPL	Price DKK
Left: Step counter Right: Standard counter (H740 mm)	1000	BI3706123	2.620

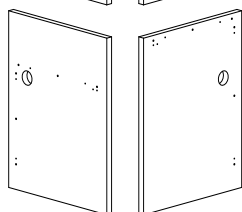

Left: Standard counter (H740 mm) Right: Step counter	1000	BI3706133	2.620
---	------	-----------	-------

STANDARD COUNTER

CONFIGURATIONS

Remember always to construct your counter from left to right when sitting behind the counter.

Standard rectangular counter with 3 standard fronts and 1 recessed front

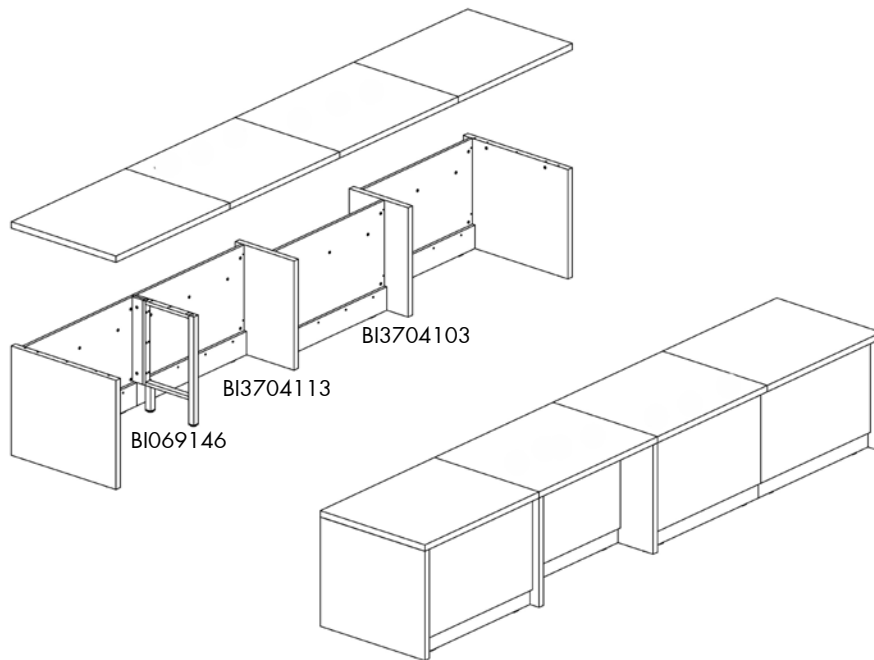

Standard rectangular and step counters

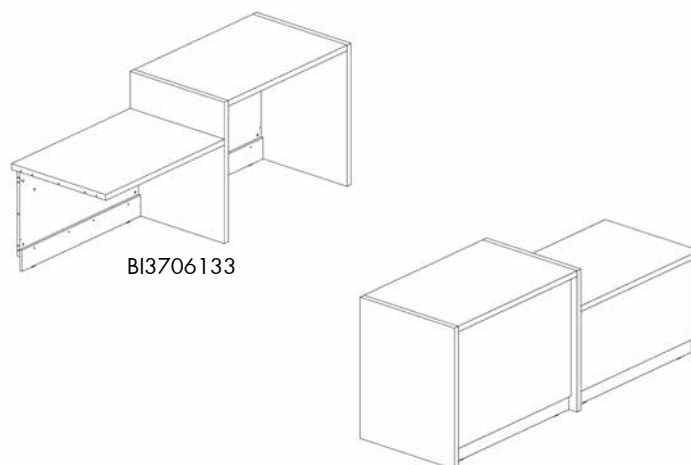

RECESSED COUNTER

CONFIGURATION NO. 3

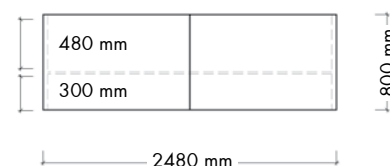

Recessed rectangular counter

Components	Article no.	Price DKK	Quantity	DKK
Recessed rectangular counter - starter (W1240 x H740 mm)	BI2101022003	5.995,00	1	5.995
Recessed rectangular counter - end (W1240 x H740 mm)	BI2103022003	5.995,00	1	5.995
Wooden front panel for rectangular counter (W1200 x H740 mm)	BI300546	2.368,00	2	4.736
Steel leg frame for recessed counter (H740 mm)	BI069546	2.979,00	1	2.979
Total price for configuration				19.705

Comments to configuration

- Monitor, office chair and text are not included in price.
- All prices are based on colours and surfaces in price group A, see pages 4-7 for colours.
- We recommend the use of desk grommets, cable rails and drawer pedestals with the Inform counter, see page 113.

RECESSED COUNTER

CONFIGURATION NO. 4

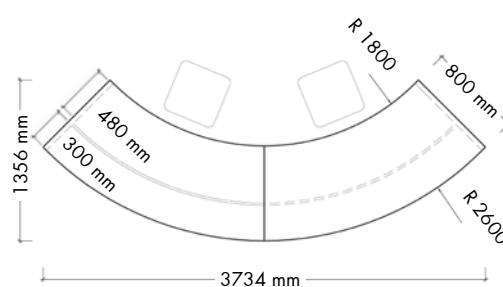

Recessed 45° curved counter

Components	Article no.	Price DKK	Quantity	DKK
45° recessed curved counter - starter (H740 mm)	BI2151429003	9.243,00	1	9.243
45° recessed curved counter - end (H740 mm)	BI2153429003	9.243,00	1	9.243
Wooden front panel for 45° curved counter (H740 mm)	BI3204543	15.820,00	2	31.640
Steel leg frame for recessed counter (H740 mm)	BI069546	2.979,00	1	2.979
Total price for configuration				53.105

Comments to configuration

- Computer, office chair, display and text are not included in price.
- All prices are based on colours and surfaces in price group A, see pages 4-7 for colours.
- We recommend the use of desk grommets, cable rails and drawer pedestals with the Inform counter, see page 113.

RECESSED COUNTER

RECTANGULAR COUNTERS

The design of Inform's recessed front panel allows for easy access on both sides of the counter and is especially suited for wheelchair use, as the front panel is placed 300 mm from the front. It is available in two heights; 740 and 1000 mm. This model can be combined with other recessed counters of the same height, step counters, height adjustable counters (only with H1000 mm standard counter), info counters, corner counters as well as display cabinets.

Recessed rectangular counter - starter

Remember to order front panel, see page 39 and leg frame/middle panel, see page 50. For counter with predrilled holes for cable conduct see pages 120-121.

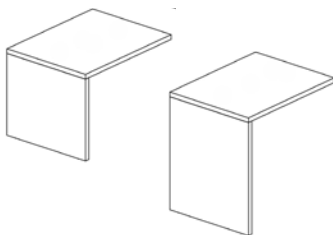

H x W x D mm	Item no. HPL	Price DKK
740 640 800	BI2101016003	5.093
740 840 800	BI2101018003	5.273
740 1040 800	BI2101020003	5.634
740 1240 800	BI2101022003	5.995
740 1440 800	BI2101024003	6.444
740 1640 800	BI2101026003	6.716
1000 640 800	BI2101036003	5.445
1000 840 800	BI2101038003	5.624
1000 1040 800	BI2101040003	5.985
1000 1240 800	BI2101042003	6.346
1000 1440 800	BI2101044003	6.796
1000 1640 800	BI2101046003	7.067

Recessed rectangular counter - middle

Remember to order front panel, see page 39 and leg frame/middle panel, see page 50. For counter with predrilled holes for cable conduct see pages 120-121.

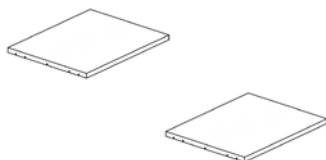

W x D mm	Item no. HPL	Price DKK
600 800	BI2102060003	2.657
800 800	BI2102080003	2.836
1000 800	BI2102081003	3.199
1200 800	BI2102082003	3.560
1400 800	BI2102084003	4.010
1600 800	BI2102086003	4.281

Recessed rectangular counter - end

Remember to order front panel, see page 39 and leg frame/middle panel, see page 50. For counter with predrilled holes for cable conduct see pages 120-121.

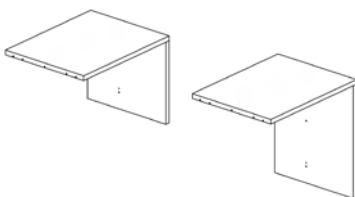

H x W x D mm	Item no. HPL	Price DKK
740 640 800	BI2103016003	5.093
740 840 800	BI2103018003	5.273
740 1040 800	BI2103020003	5.634
740 1240 800	BI2103022003	5.995
740 1440 800	BI2103024003	6.444
740 1640 800	BI2103026003	6.716
1000 640 800	BI2103036003	5.445
1000 840 800	BI2103038003	5.624
1000 1040 800	BI2103040003	5.985
1000 1240 800	BI2103042003	6.346
1000 1440 800	BI2103044003	6.796
1000 1640 800	BI2103046003	7.067

RECESSED COUNTER

FREESTANDING RECTANGULAR COUNTERS AND FRONT PANELS

The design of Inform's recessed front panel allows for easy access on both sides of the counter and is especially suited for wheelchair use, as the front panel is placed 300 mm from the front. Remember to order front panel.

Recessed rectangular counter - freestanding

Remember to order front panel. For counter with predrilled holes for cable conduct see pages 120-121.

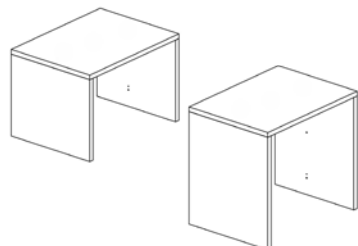

H x W x D mm	Item no. HPL	Price DKK
740 680 800	BI2104016003	7.530
740 880 800	BI2104018003	7.709
740 1080 800	BI2104020003	8.070
740 1280 800	BI2104022003	8.430
740 1480 800	BI2104024003	8.881
740 1680 800	BI2104026003	9.153
1000 680 800	BI2104036003	8.231
1000 880 800	BI2104038003	8.411
1000 1080 800	BI2104040003	8.772
1000 1280 800	BI2104042003	9.133
1000 1480 800	BI2104044003	9.583
1000 1680 800	BI2104046003	9.853

Wooden front panel for recessed rectangular counter

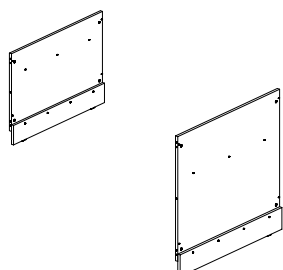

H x W mm	Item no. Melamine	Price DKK	Item no. Veneer	Price DKK
740 600	BI300146	1.543	BI300142	2.541
740 800	BI300346	1.773	BI300342	2.924
740 1000	BI300446	2.135	BI300442	3.517
740 1200	BI300546	2.368	BI300542	3.900
740 1400	BI300646	2.623	BI300642	4.318
740 1600	BI300746	3.020	BI300742	4.972
1000 600	BI300166	2.708	BI300162	4.460
1000 800	BI300366	2.761	BI300362	4.547
1000 1000	BI300466	3.547	BI300462	5.840
1000 1200	BI300566	3.661	BI300562	6.031
1000 1400	BI300666	3.697	BI300662	6.092
1000 1600	BI300766	3.734	BI300762	6.150

Acrylic front panel for recessed rectangular counter

Melaminecoated wooden frame.

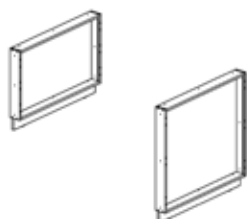

H x W mm	Item no. Acrylic & melamine	Price DKK
740 600	BI310146	5.790
740 800	BI310346	5.962
740 1000	BI310446	6.667
740 1200	BI310546	7.016
740 1400	BI310646	7.542
740 1600	BI310746	8.054
1000 600	BI310166	6.734
1000 800	BI310366	6.912
1000 1000	BI310466	7.613
1000 1200	BI310566	7.963
1000 1400	BI310666	8.489
1000 1600	BI310766	9.000

RECESSED COUNTER

45° CURVED COUNTERS

The design of Inform's recessed front panel allows for easy access on both sides of the counter and is especially suited for wheelchair use, as the front panel is placed 300 mm from the front. It is available in two heights; 740 and 1000 mm. This model can be combined with other recessed counters of the same height, step counters, height adjustable counters (only with H1000 mm standard counter), info counters, corner counters as well as display cabinets.

45° recessed curved counter - starter

Remember to order front panel, see page 41 and leg frame/middle panel, see page 50. For counter with predrilled holes for cable conduct see pages 120-121.

H	x	W	x	D
mm				
740		2030		800
1000		2030		800

Item no.	Price
HPL	DKK
BI2151429003	9.243
BI2151449003	9.595

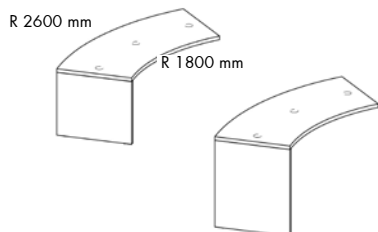

45° recessed curved counter - middle

Remember to order front panel, see page 41 and leg frame/middle panel, see page 50. For counter with predrilled holes for cable conduct see pages 120-121.

W	x	D
mm		
1800		800

Item no.	Price
HPL	DKK
BI2152489003	6.808

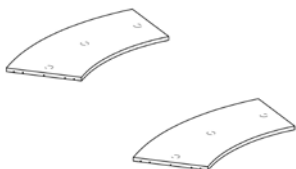

45° recessed curved counter - end

Remember to order front panel, see page 41 and leg frame/middle panel, see page 50. For counter with predrilled holes for cable conduct see pages 120-121.

H	x	W	x	D
mm				
740		2030		800
1000		2030		800

Item no.	Price
HPL	DKK
BI2153429003	9.243
BI2153449003	9.595

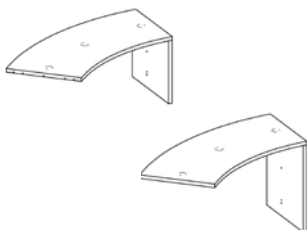

RECESSED COUNTER

FREESTANDING 45° CURVED COUNTERS AND FRONT PANELS

The design of Inform's recessed front panel allows for easy access on both sides of the counter and is especially suited for wheelchair use, as the front panel is placed 300 mm from the front. Remember to order front panel.

45° recessed curved counter - freestanding

Remember to order front panel. For counter with predrilled holes for cable conduct see pages 120-121.

H x W x D mm	Item no. HPL	Price DKK
740 2070 800	BI2154429003	11.679
1000 2070 800	BI2154449003	12.381

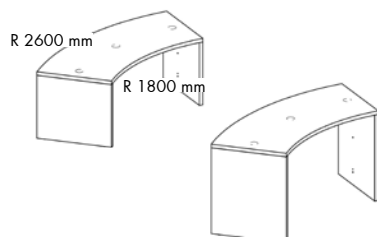

Wooden front panel for 45° recessed curved counter

H x W mm	Item no. HPL	Price DKK
740 1760	BI3204543	15.820
1000 1760	BI3204563	18.503

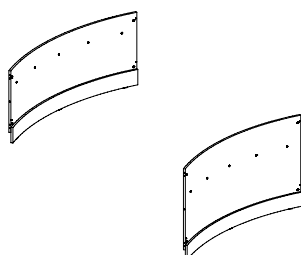

Acrylic front panel for 45° recessed curved counter

Melaminecoated wooden frame.

H x W mm	Item no. Acrylic & melamine	Price DKK
740 1760	BI3304546	11.351
1000 1760	BI3304566	12.118

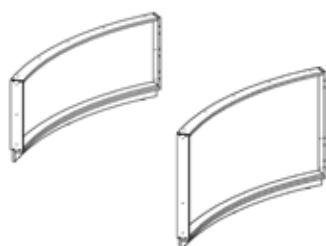

RECESSED COUNTER

90° CURVED COUNTERS

The design of Inform's recessed front panel allows for easy access on both sides of the counter and is especially suited for wheelchair use, as the front panel is placed 300 mm from the front. It is available in two heights; 740 and 1000 mm. This model can be combined with other recessed counters of the same height, step counters, height adjustable counters (only with H1000 mm standard counter), info counters, corner counters as well as display cabinets.

90° recessed curved counter - starter

Remember to order front panel, see page 43 and leg frame/middle panel, see page 50. For counter with predrilled holes for cable conduct see pages 120-121.

H	x	W	x	D
mm				
740		2220		800
1000		2220		800

Item no.	Price
HPL	DKK
BI2151929003	9.966
BI2151949003	10.317

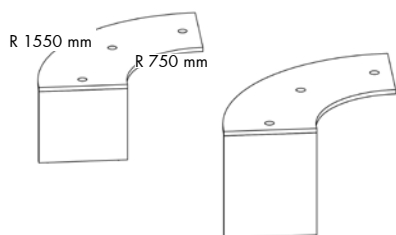

90° recessed curved counter - middle

Remember to order front panel, see page 43 and leg frame/middle panel, see page 50. For counter with predrilled holes for cable conduct see pages 120-121.

W	x	D
mm		
1800		800

Item no.	Price
HPL	DKK
BI2152989003	7.531

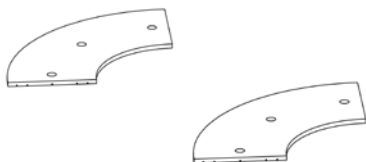

90° recessed curved counter - end

Remember to order front panel, see page 43 and leg frame/middle panel, see page 50. For counter with predrilled holes for cable conduct see pages 120-121.

H	x	W	x	D
mm				
740		2220		800
1000		2220		800

Item no.	Price
HPL	DKK
BI2153929003	9.966
BI2153949003	10.317

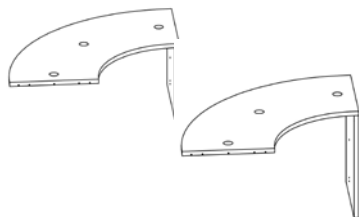

RECESSED COUNTER

FREESTANDING 90° CURVED COUNTERS AND FRONT PANELS

The design of Inform's recessed front panel allows for easy access on both sides of the counter and is especially suited for wheelchair use, as the front panel is placed 300 mm from the front. Remember to order front panel.

90° recessed curved counter - freestanding

Remember to order front panel. For counter with predrilled holes for cable conduct see pages 120-121.

H	x	W	x	D
mm				
740		2250		800
1000		2250		800

Item no.	Price
HPL	DKK
BI2154929003	12.403
BI2154949003	13.103

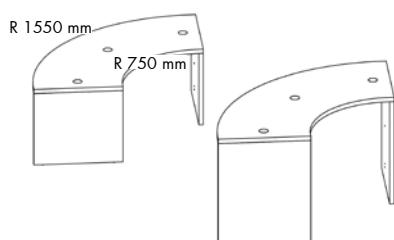

Wooden front panel for 90° recessed curved counter

H	x	W
mm		
740		1768
1000		1768

Item no.	Price
HPL	DKK
BI3209043	16.087
BI3209063	16.806

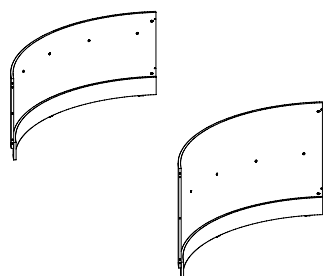

Acrylic front panel for 90° recessed curved counter

Melaminecoated wooden frame.

H	x	W
mm		
740		1768
1000		1768

Item no.	Price
Acrylic & melamine	DKK
BI3309046	14.645
BI3309066	15.594

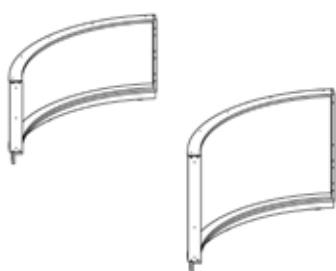

RECESSED COUNTER

RECTANGULAR COUNTERS - FOR CONNECTING TO STANDARD COUNTERS

The design of Inform's recessed front panel allows for easy access on both sides of the counter and is especially suited for wheelchair use, as the front panel is placed 300 mm from the front. It is available in two heights; 740 and 1000 mm. This model can be combined with standard counters of the same height by connecting with a middle panel (as the counter top is 40 mm wider than the recessed rectangular counter).

Recessed rectangular counter - starter - connected with middle panel

Remember to order front panel, see page 45 and middle panel, see page 50. For counter with predrilled holes for cable conduct see pages 120-121.

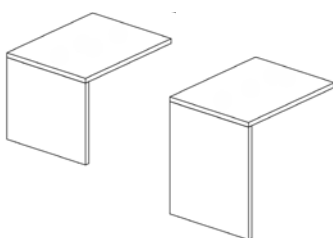

H x W x D mm	Item no. HPL	Price DKK
740 680 800	BI2121016003	5.093
740 880 800	BI2121018003	5.273
740 1080 800	BI2121020003	5.634
740 1280 800	BI2121022003	5.995
740 1480 800	BI2121024003	6.444
740 1680 800	BI2121026003	6.716
1000 680 800	BI2121036003	5.445
1000 880 800	BI2121038003	5.624
1000 1080 800	BI2121040003	5.985
1000 1280 800	BI2121042003	6.346
1000 1480 800	BI2121044003	6.796
1000 1680 800	BI2121046003	7.067

Recessed rectangular counter - middle - connected with middle panel

Remember to order front panel, see page 45 and middle panel, see page 50. For counter with predrilled holes for cable conduct see pages 120-121.

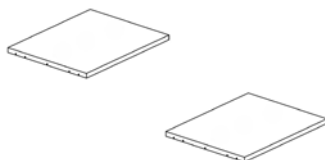

W x D mm	Item no. HPL	Price DKK
640 800	BI2122060003	2.657
840 800	BI2122080003	2.836
1040 800	BI2122081003	3.199
1240 800	BI2122082003	3.560
1440 800	BI2122084003	4.010
1640 800	BI2122086003	4.281

Recessed rectangular counter - end - connected with middle panel

Remember to order front panel, see page 45 and middle panel, see page 50. For counter with predrilled holes for cable conduct see pages 120-121.

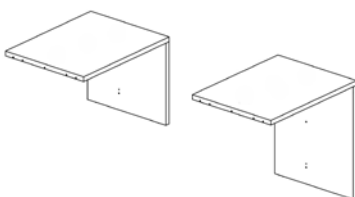

H x W x D mm	Item no. HPL	Price DKK
740 680 800	BI2123016003	5.093
740 880 800	BI2123018003	5.273
740 1080 800	BI2123020003	5.634
740 1280 800	BI2123022003	5.995
740 1480 800	BI2123024003	6.444
740 1680 800	BI2123026003	6.716
1000 680 800	BI2123036003	5.445
1000 880 800	BI2123038003	5.624
1000 1080 800	BI2123040003	5.985
1000 1280 800	BI2123042003	6.346
1000 1480 800	BI2123044003	6.796
1000 1680 800	BI2123046003	7.067

RECESSED COUNTER

RECTANGULAR FRONT PANELS

Remember to order front panel.

Wooden front panel for recessed rectangular counter

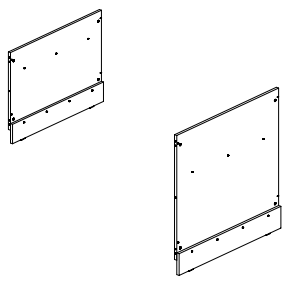
	H x W mm	Item no. Melamine	Price DKK	Item no.		Price DKK
				Veneer		
	740 600	BI300146	1.543	BI300142	2.541	
	740 800	BI300346	1.773	BI300342	2.924	
	740 1000	BI300446	2.135	BI300442	3.517	
	740 1200	BI300546	2.368	BI300542	3.900	
	740 1400	BI300646	2.623	BI300642	4.318	
	740 1600	BI300746	3.020	BI300742	4.972	
	1000 600	BI300166	2.708	BI300162	4.460	
	1000 800	BI300366	2.761	BI300362	4.547	
	1000 1000	BI300466	3.547	BI300462	5.840	
	1000 1200	BI300566	3.661	BI300562	6.031	
1000 1400	BI300666	3.697	BI300662	6.092		
1000 1600	BI300766	3.734	BI300762	6.150		

Acrylic front panel for recessed rectangular counter

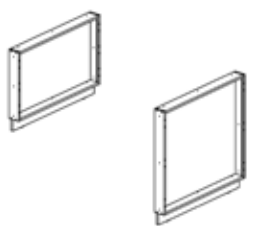
Melaminecoated wooden frame.	H x W mm	Item no. Acrylic & melamine	Price DKK
	740 600	BI310146	5.790
	740 800	BI310346	5.962
	740 1000	BI310446	6.667
	740 1200	BI310546	7.016
	740 1400	BI310646	7.542
	740 1600	BI310746	8.054
	1000 600	BI310166	6.734
	1000 800	BI310366	6.912
	1000 1000	BI310466	7.613
	1000 1200	BI310566	7.963
1000 1400	BI310666	8.489	
1000 1600	BI310766	9.000	

RECESSED COUNTER

45° CURVED COUNTERS - FOR CONNECTING TO STANDARD COUNTERS

The design of Inform's recessed front panel allows for easy access on both sides of the counter and is especially suited for wheelchair use, as the front panel is placed 300 mm from the front. It is available in two heights; 740 and 1000 mm. This model can be combined with standard counters of the same height by connecting with a middle panel (as the counter top is 40 mm wider than the recessed 45° curved counter).

45° recessed curved counter - starter - connected with middle panel

Remember to order front panel, see page 47 and middle panel, see page 50. For counter with predrilled holes for cable conduct see pages 120-121.

H	x	W	x	D
mm				
740		2030		800
1000		2030		800

Item no. HPL	Price DKK
BI2161429003	9.243
BI2161449003	9.595

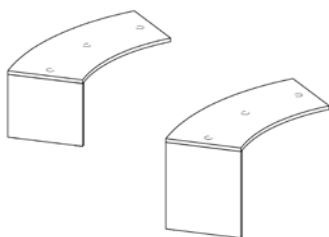

45° recessed curved counter - end - connected with middle panel

Remember to order front panel, see page 47 and middle panel, see page 50. For counter with predrilled holes for cable conduct see pages 120-121.

H	x	W	x	D
mm				
740		2030		800
1000		2030		800

Item no. HPL	Price DKK
BI2163429003	9.243
BI2163449003	9.595

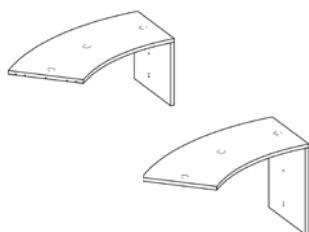

RECESSED COUNTER

45° CURVED FRONT PANELS

Remember to order front panel.

Wooden front panel for 45° recessed curved counter

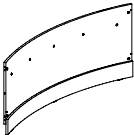
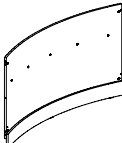
	H x W mm	Item no. HPL	Price DKK
	740 1760	BI3204543	15.820
	1000 1760	BI3204563	18.503

Acrylic front panel for 45° recessed curved counter

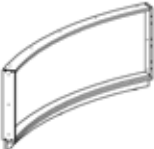
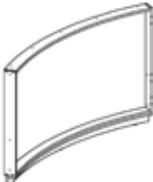
Melaminecoated wooden frame.	H x W mm	Item no. Acrylic & melamine	Price DKK
	740 1760	BI3304546	11.351
	1000 1760	BI3304566	12.118

RECESSED COUNTER

90° CURVED COUNTERS - FOR CONNECTING TO STANDARD COUNTERS

The design of Inform's recessed front panel allows for easy access on both sides of the counter and is especially suited for wheelchair use, as the front panel is placed 300 mm from the front. It is available in two heights; 740 and 1000 mm. This model can be combined with standard counters of the same height by connecting with a middle panel (as the counter top is 40 mm wider than the recessed 90° curved counter).

90° recessed curved counter - starter - connected with middle panel

Remember to order front panel, see page 49 and middle panel, see page 50. For counter with predrilled holes for cable conduct see pages 120-121.

H	x	W	x	D
mm				
740		2220		800
1000		2220		800

Item no. HPL	Price DKK
BI2161929003	9.966
BI2161949003	10.317

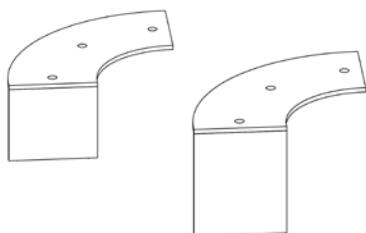

90° recessed curved counter - end - connected with middle panel

Remember to order front panel, see page 49 and middle panel, see page 50. For counter with predrilled holes for cable conduct see pages 120-121.

H	x	W	x	D
mm				
740		2220		800
1000		2220		800

Item no. HPL	Price DKK
BI2163929003	9.966
BI2163949003	10.317

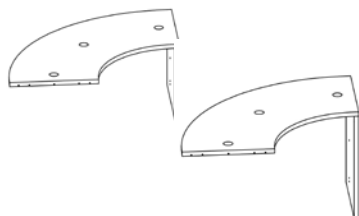

RECESSED COUNTER

90° CURVED FRONT PANELS

Remember to order front panel.

Wooden front panel for 90° recessed curved counter

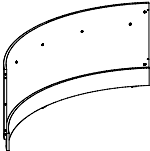
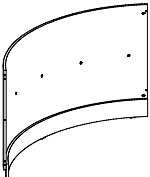
	H x W mm	Item no. HPL	Price DKK
	740 1768	BI3209043	16.087
	1000 1768	BI3209063	16.806

Acrylic front panel for 90° recessed curved counter

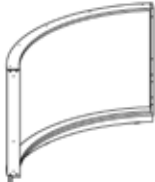
Melaminecoated wooden frame.	H x W mm	Item no. Acrylic & melamine	Price DKK
	740 1768	BI3309046	14.645
	1000 1768	BI3309066	15.594

RECESSED COUNTERS

CONNECTIONS

If you wish to combine a recessed rectangular/curved counter with a recessed rectangular/curved counter of the same height, you must use a steel leg frame.

If you wish to combine a recessed rectangular/curved counter with standard rectangular/curved or step counter, you must use a middle panel.

Steel leg frame for recessed counters

Must be used when assembling 2 recessed modules of the same height.

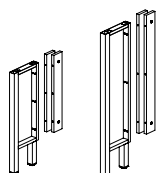

Finish	H mm	Item no. Melamine/veneer	Price DKK
Melamine	740	BI069546	2.979
	1000	BI069566	3.338
Veneer	740	BI069542	4.906
	1000	BI069562	5.498

Middle panel for recessed and standard counters

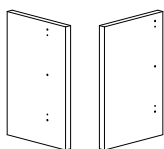

Side of panel	H mm	Item no. HPL	Price DKK
Left : Recessed counter Right: Standard counter	740	BI3704103	1.281

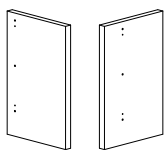

Left: Standard counter Right: Recessed counter	740	BI3704113	1.281
---	-----	-----------	-------

Middle panel for recessed and step counter

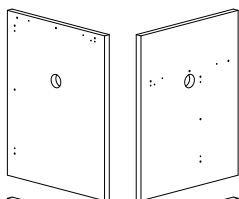

Side of panel	H mm	Item no. HPL	Price DKK
Left: Step counter Right: Recessed counter	1000	BI3706143	2.620

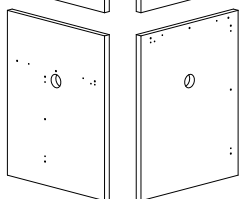

Left: Recessed counter Right: Step counter	1000	BI3706153	2.620
---	------	-----------	-------

Middle panel for height adjustable and recessed counter

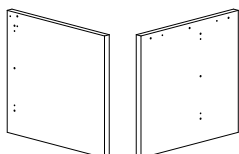

Side of panel	H mm	Item no. HPL	Price DKK
Left: Height adjustable counter Right: Recessed counter	740	BI3704163	1.281

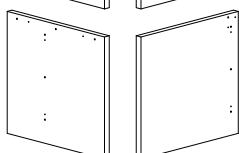

Left: Recessed counter Right: Height adjustable counter	740	BI3704173	1.281
--	-----	-----------	-------

RECESSED COUNTERS

CONFIGURATIONS

If you wish to combine a recessed counter with standard rectangular/curved, height adjustable or step counter, you must use one of the panels on page 50. Remember always to construct your counter from left to right when sitting behind the counter.

Rectangular counters with 2 standard fronts and 1 recessed front

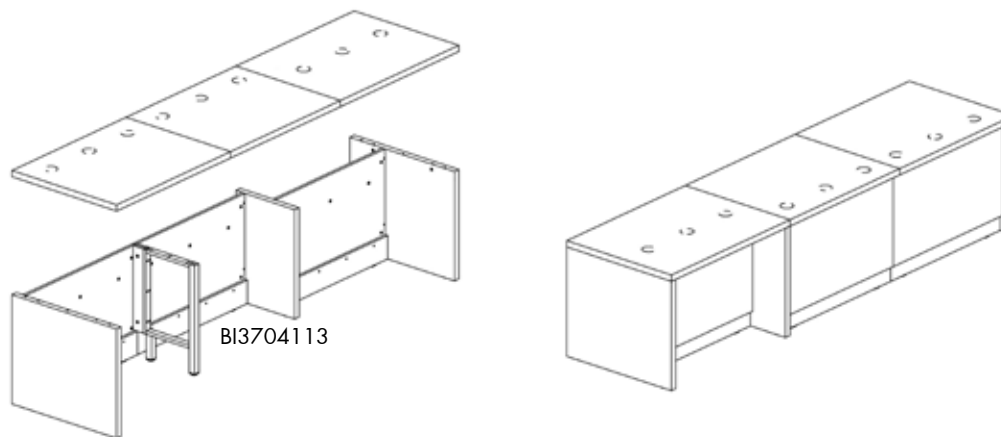

Recessed and step counters

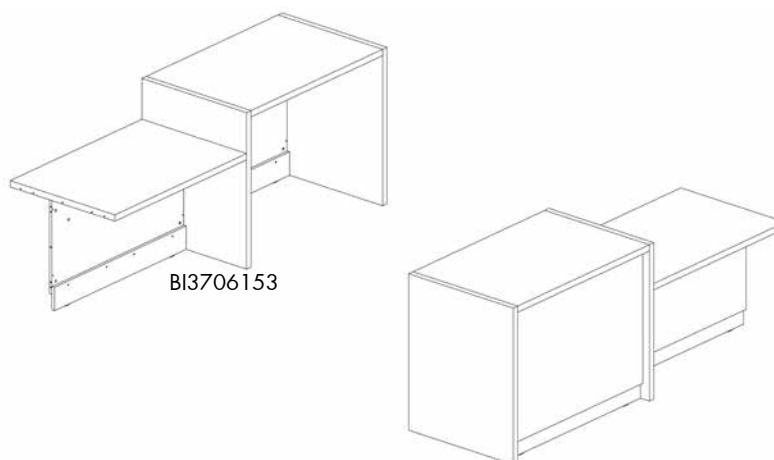

Recessed rectangular and height adjustable counter

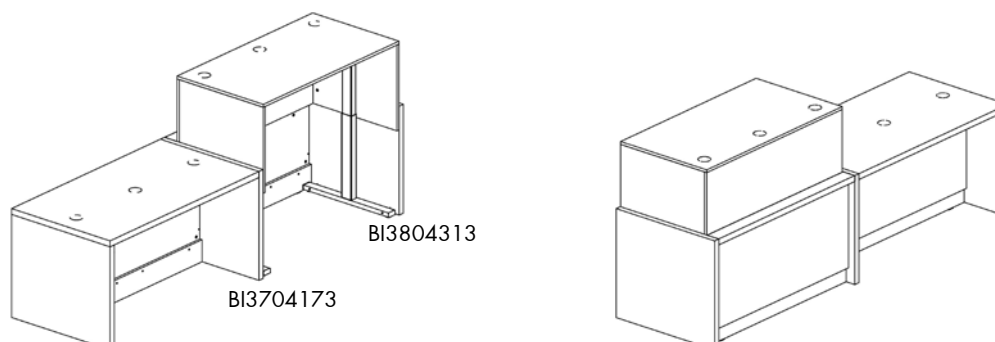

STEP COUNTER

CONFIGURATION NO. 5

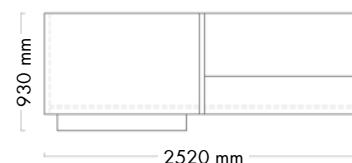

Rectangular & step counters (with counter shelf and bag shelf)

Components	Article no.	Price DKK	Quantity	DKK
Rectangular counter - starter (W1240 x H740 mm)	BI2001022003	5.995,00	1	5.995
Wooden front panel for rectangular counter (W1200 x H740 mm)	BI300546	2.368,00	1	2.368
Counter shelf and front for rectangular counter - starter (W1240 mm)	BI4101056	3.842,00	1	3.842
Middle panel for step and standard counter (H1000 mm)	BI3706133	2.620,00	1	2.620
Rectangular counter - end (W1240 x H1000 mm)	BI2003042003	6.346,00	1	6.346
Wooden front panel for rectangular counter (W1200 x H1000 mm)	BI300566	3.661,00	1	3.661
Wooden bag shelf for rectangular counter (W1200 mm)	BI81053	1.535,00	1	1.535
Total price for configuration				26.367

Comments to configuration

- Monitor, office chair and text are not included in price.
- All prices are based on colours and surfaces in price group A, see pages 4-7 for colours.
- We recommend the use of desk grommets, cable rails and drawer pedestals with the Inform counter, see page 113.
- The bag shelf is in fact 1000 mm long, adapted to a 1200 mm front panel.

STEP COUNTER

CONFIGURATION NO. 6

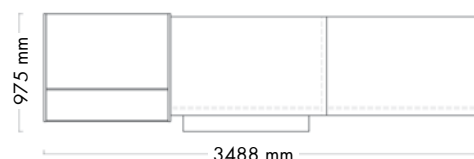

Rectangular & step counters with presentation cabinet (with bag shelf)

Components	Article no.	Price DKK	Quantity	DKK
Rectangular counter - starter (W1240 x H740 mm)	BI2001022003	5.995,00	1	5.995
Wooden front panel for rectangular counter (W1200 x H740 mm)	BI300546	2.368,00	1	2.368
Middle panel for step and standard counter (H1000 mm)	BI3706133	2.620,00	1	2.620
Rectangular counter - middle (W1200 x H1000 mm)	BI2002082003	3.740,00	1	3.740
Wooden front panel for rectangular counter (W1200 x H1000 mm)	BI300566	3.661,00	1	3.661
Display cabinet with 2 shelves & shelving options (W1008 x H1130 mm)	BI525127006	12.798,00	1	12.798
Steel intermediate shelf with backedge (W1000 x D300 mm)	B401803131	499,00	4	1.996
Wooden bag shelf for rectangular counter (W1200 mm)	BI81053	1.535,00	1	1.535
Total price for configuration				34.713

Comments to configuration

- Monitor, office chair and text are not included in price.
- All prices are based on colours and surfaces in price group A, see pages 4-7 for colours.
- We recommend the use of desk grommets, cable rails and drawer pedestals with the Inform counter, see page 113.
- The bag shelf is in fact 1000 mm long, adapted to a 1200 mm front panel.
- Shelves are not included in presentation cabinet. For full overview of shelving options for presentation cabinet, see page 101.

STEP COUNTER

COUNTER TOPS

Vary the height of the Inform counter by adding a simple module - a step counter top. The counter top can be used for the two heights; 740 and 1000 mm. To combine with standard and recessed counters, see page 57.

Step counter top

Remember to order middle panels. For counter with predrilled holes for cable conduct see pages 120-121.



H x W x D mm	Item no. HPL	Price DKK
740 600 800	BI2002060003	2.836
740 800 800	BI2002080003	3.178
740 1000 800	BI2002081003	3.379
740 1200 800	BI2002082003	3.740
740 1400 800	BI2002084003	4.195
740 1600 800	BI2002086003	4.460

Steel leg frame

Must be used when assembling 2 modules of the same height.

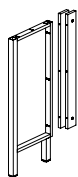

H mm	Item no. Melamine	Price DKK	Item no. Veneer	Price DKK
1000	BI069166	3.184	BI069162	5.244

STEP COUNTER

FRONT PANELS

Vary the height of the Inform counter by adding a simple module - a step counter top. The counter top can be used for the two heights; 740 and 1000 mm. To combine with standard and recessed counters, see page 57.

Wooden front panel for step counter

	H x W mm	Item no. Melamine	Price DKK	Item no. Veneer	Price DKK
	740 600	BI300146	1.543	BI300142	2.541
	740 800	BI300346	1.773	BI300342	2.924
	740 1000	BI300446	2.135	BI300442	3.517
	740 1200	BI300546	2.368	BI300542	3.900
	740 1400	BI300646	2.623	BI300642	4.318
	740 1600	BI300746	3.020	BI300742	4.972
	1000 600	BI300166	2.708	BI300162	4.460
	1000 800	BI300366	2.761	BI300362	4.547
	1000 1000	BI300466	3.547	BI300462	5.840
	1000 1200	BI300566	3.661	BI300562	6.031
1000 1400	BI300666	3.697	BI300662	6.092	
1000 1600	BI300766	3.734	BI300762	6.150	

Acrylic front panel for step counter

Melaminecoated wooden frame.	H x W mm	Item no. Acrylic & melamine	Price DKK
	74 600	BI310146	5.790
	740 800	BI310346	5.962
	740 1000	BI310446	6.667
	740 1200	BI310546	7.016
	740 1400	BI310646	7.542
	740 1600	BI310746	8.054
	1000 600	BI310166	6.734
	1000 800	BI310366	6.912
	1000 1000	BI310466	7.613
	1000 1200	BI310566	7.963
	1000 1400	BI310666	8.489
	1000 1600	BI310766	9.000

STEP COUNTER

MIDDLE PANELS

It is necessary to order side and middle panels for the step counter, depending on the construction of your complete counter. See overview of panels below. Remember always to construct your counter from left to right when sitting behind the counter!

Middle panel for step and standard counter

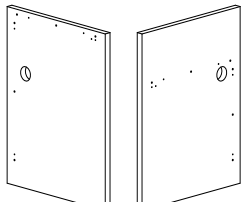
	Side of panel	H mm	Item no. HPL	Price DKK
	Left: Step counter Right: Standard counter (H740 mm)	1000	BI3706123	2.620
	Left: Standard counter (H740 mm) Right: Step counter	1000	BI3706133	2.620

Middle panel for step and recessed counter

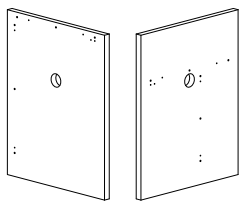
	Side of panel	H mm	Item no. HPL	Price DKK
	Left: Step counter Right: Recessed counter	1000	BI3706143	2.620
	Left: Recessed counter Right: Step counter	1000	BI3706153	2.620

STEP COUNTER

CONFIGURATIONS

The counter can be installed using either the middle panel or leg frame, depending on whether the counter is placed next to another standard counter or display cabinet. See overview of middle panels on page 56. Remember always to construct your counter from left to right when sitting behind the counter!

Standard and step counter

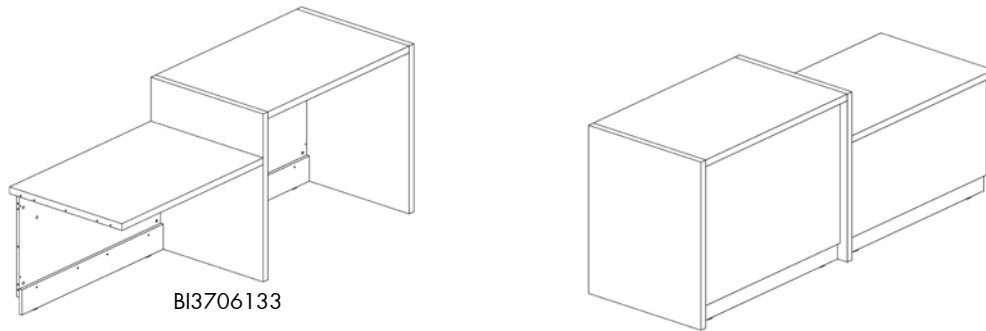

Step, recessed and height adjustable counter

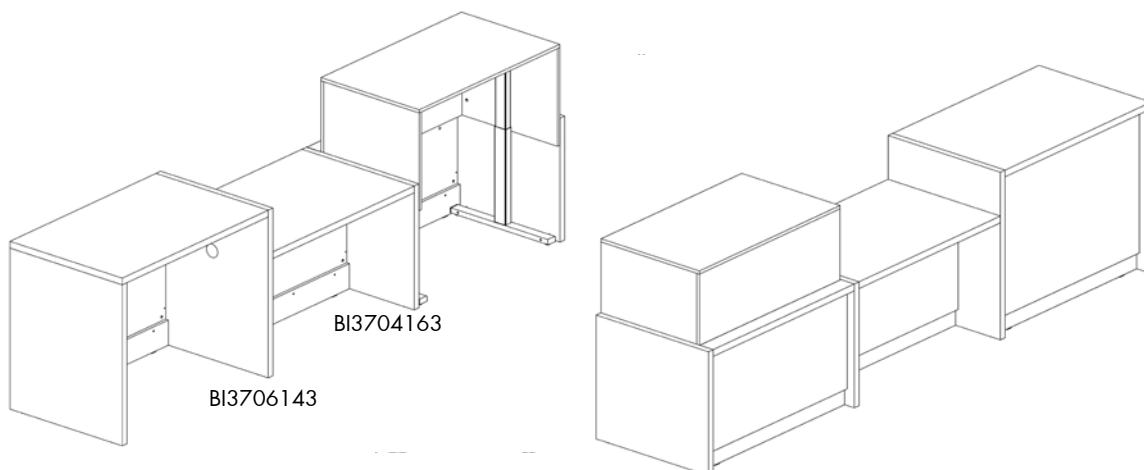

CORNER COUNTER

CONFIGURATION NO. 11

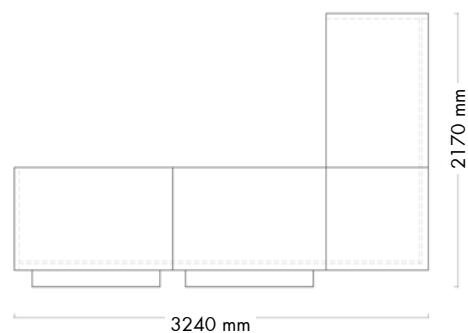

Rectangular & square corner counters (with bag shelves)

Components	Article no.	Price DKK	Quantity	DKK
Rectangular counter - starter (W1240 x H740 mm)	BI2001022003	5.995,00	1	5.995
Rectangular counter - middle (W1200 x H740 mm)	BI2002082003	3.740,00	1	3.740
Rectangular counter - end (W1240 x H740 mm)	BI2003022003	5.995,00	1	5.995
Square corner counter top (H740 mm)	BI26530003	3.427,00	1	3.427
Wooden front panel for rectangular counter (W1200 x H740 mm)	BI300546	2.368,00	3	7.104
Wooden front panel for square corner counter (H740 mm)	BI340346	4.878,00	1	4.878
Wooden bag shelf for rectangular counter (W1200 mm)	BI81053	1.535,00	2	3.070
Steel leg frame (H740 mm)	BI069146	2.855,00	3	8.565
Monitor arm	B401184	6.354,00	1	6.354
Total price for configuration				49.128

Comments to configuration

- Monitor, key board, office chairs and text are not included in price.
- All prices are based on colours and surfaces in price group A, see pages 4-7 for colours.
- We recommend the use of desk grommets, cable rails and drawer pedestals with the Inform counter, see page 113.
- The bag shelf is in fact 1000 mm long, adapted to a 1200 mm front panel.
- It is necessary to drill an Ø80 mm hole for the monitor arm on site or modify the article number for counter for predrilled hole, see pages 120-121.

CORNER COUNTER

CONFIGURATION NO. 12

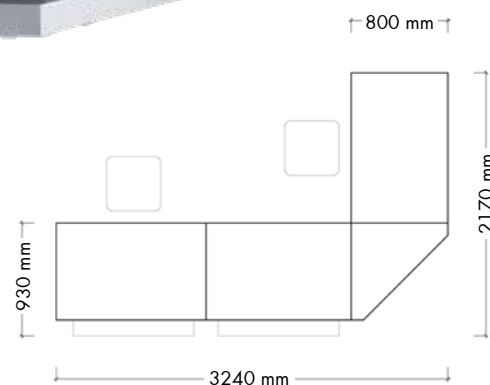

Rectangular & triangular corner counters (with bag shelves)

Components	Article no.	Price DKK	Quantity	DKK
Rectangular counter - starter (W1240 x H740 mm)	BI2001022003	5.995,00	1	5.995
Rectangular counter - middle (W1200 x H740 mm)	BI2002082003	3.740,00	1	3.740
Rectangular counter - end (W1240 x H740 mm)	BI2003022003	5.995,00	1	5.995
Wooden front panel for rectangular counter (W1200 x H740 mm)	BI300546	2.368,00	3	7.104
Triangular corner counter top (H740 mm)	BI26833003	3.804,00	1	3.804
Wooden front panel for triangular corner counter (H740 mm)	BI345346	3.562,00	1	3.562
Wooden bag shelf for rectangular counter (W1200 mm)	BI81053	1.535,00	2	3.070
Steel leg frame (H740 mm)	BI069146	2.855,00	3	8.565
Total price for configuration				41.835

Comments to configuration

- Monitor, office chair and text are not included in price.
- All prices are based on colours and surfaces in price group A, see pages 4-7 for colours.
- We recommend the use of desk grommets, cable rails and drawer pedestals with the Inform counter, see page 113.
- The bag shelf is in fact 1000 mm long, adapted to a 1200 mm front panel.

CORNER COUNTER

SQUARE CORNER COUNTER TOPS, FRONT PANELS AND LEG FRAME

The corner counter is ideal for combining with the rectangular counter and the info table. The corner counter creates a sharp angle with no optical interruptions, maintaining the design of a continuous frame.

Square corner counter top

Remember to order leg frame and front panel. For counter with predrilled holes for cable conduct see pages 120-121.

W	x	D
mm		
800	800	

Item no. HPL	Price DKK
BI26530003	3.427



Wooden front panel for square corner counter

Remember to order leg frame.

H	x	W	x	D
mm				
740	800	800	800	
1000	800	800	800	

Item no. Melamine	Price DKK	Item no. Veneer	Price DKK
BI340346	4.878	BI340342	8.035
BI340366	5.591	BI340362	9.208

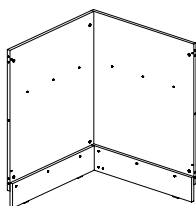
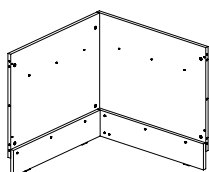

Steel leg frame

Must be used when assembling 2 modules of the same height.

H
mm
740
1000

Item no. Melamine	Price DKK	Item no. Veneer	Price DKK
BI069146	2.855	BI069142	4.702
BI069166	3.184	BI069162	5.244

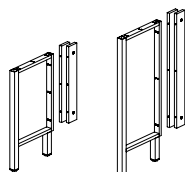

CORNER COUNTER

TRIANGULAR CORNER COUNTER TOPS, FRONT PANELS AND LEG FRAME

The triangular corner counter can be used for combining many of the other Inform counters. Create an open, informal look with the triangular corner counter and make a contrast to the linear lines usually found in a library.

Triangular corner counter top

Remember to order leg frame and front panel. For counter with predrilled holes for cable conduct see pages 120-121.

W	x	D
mm		
800		800

Item no. HPL	Price DKK
BI26833003	3.804

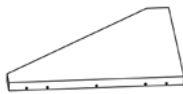

Wooden front panel for triangular corner counter

Remember to order leg frame.

H	x	W	x	D
mm				
740		800		800
1000		800		800

Item no. Melamine	Price DKK	Item no. Veneer	Price DKK
BI345346	3.562	BI345342	5.865
BI345366	3.844	BI345362	6.331

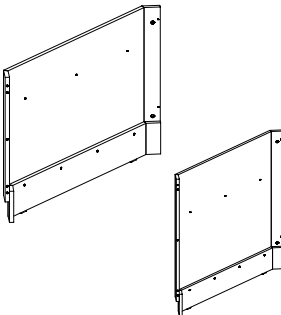

Steel leg frame

Must be used when assembling 2 modules of the same height.

H
mm
740
1000

Item no. Melamine	Price DKK	Item no. Veneer	Price DKK
BI069146	2.855	BI069142	4.702
BI069166	3.184	BI069162	5.244

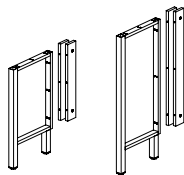

INFO TABLE

CONFIGURATION NO. 13



45° & 90° curved counters & info table with foot

Components	Article no.	Price DKK	Quantity	DKK
45° curved counter - starter (H740 mm)	BI2051428003	9.243,00	1	9.243
45° curved counter - middle (H740 mm)	BI2052488003	6.808,00	1	6.808
Wooden front panel for 45° curved counter (H740 mm)	BI3204543	15.820,00	2	31.640
90° curved counter - middle (H740 mm)	BI2052988003	7.531,00	1	7.531
Wooden front panel for 90° curved counter (H740 mm)	BI3209043	16.087,00	1	16.087
Info table - end (W800 x H740 mm)	BI27030343	4.695,00	1	4.695
Wooden side panel for info table (H740 mm)	BI38546	2.963,00	1	2.963
Steel leg frame (H740 mm)	BI069146	2.855,00	3	8.565
Monitor arm	B401184	6.354,00	1	6.354
Total price for configuration				93.886

Comments to configuration

- Monitor, key board, office chair, chairs and text are not included in price.
- All prices are based on colours and surfaces in price group A, see pages 4-7 for colours.
- We recommend the use of desk grommets, cable rails and drawer pedestals with the Inform counter, see page 113.
- It is necessary to drill an Ø80 mm hole for the monitor arm on site or modify the article number for counter for predrilled hole, see pages 120-121.

INFO TABLE

CONFIGURATION NO. 14

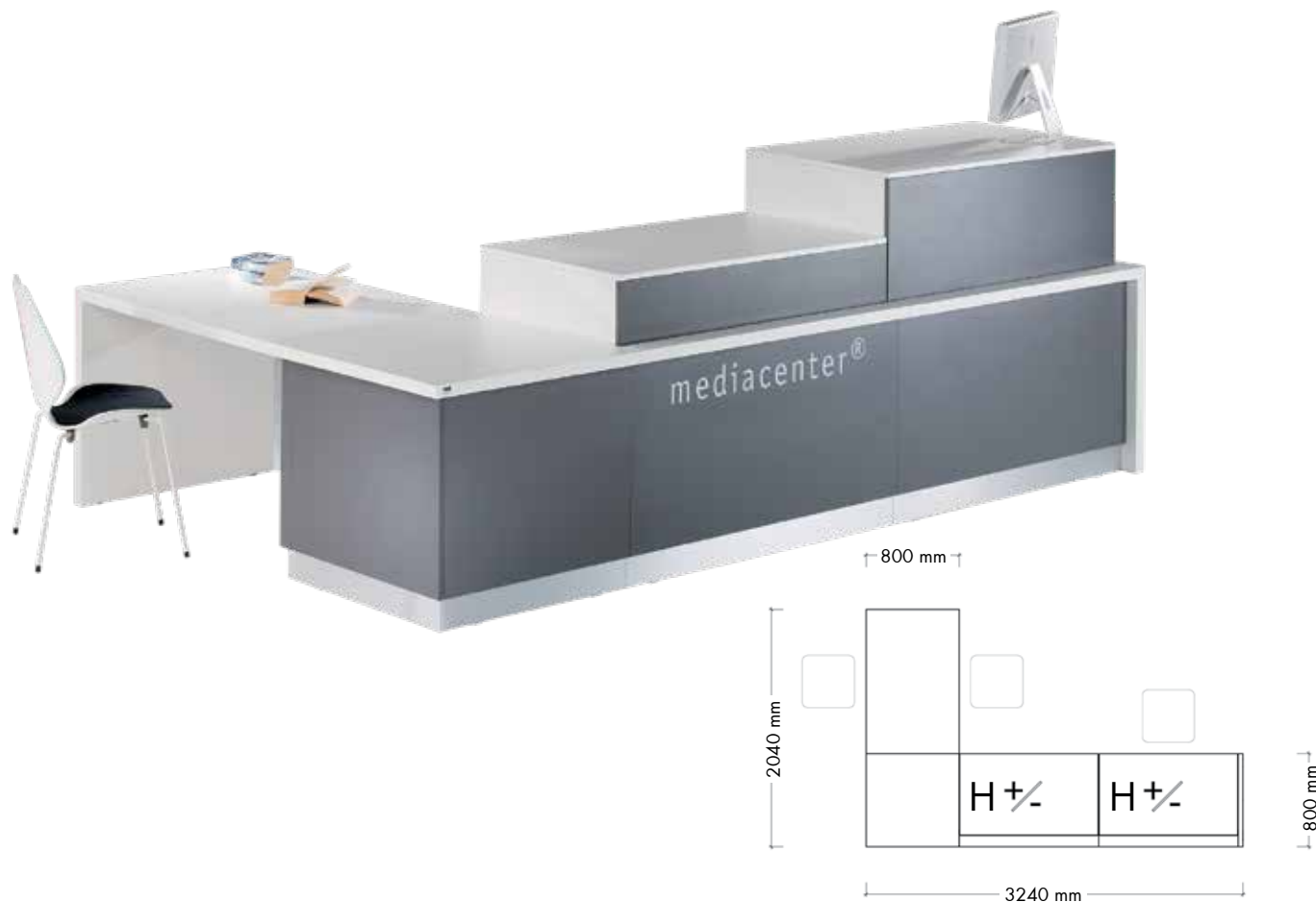

Height adjustable counter, corner counter & info table with panel

Components	Article no.	Price DKK	Quantity	DKK
Left side panel for height adjustable counter (H740 mm)	BI3804303	2.345,00	1	2.345
Height adjustable counter - starter, middle and end (W1200 mm)	BI24015006	29.248,00	2	58.496
Wooden front panel for height adjustable counter (W1200 x H740 mm)	BI350546	4.095,00	2	8.190
Square corner counter top for height adjustable counter on left side	BI26520003	3.522,00	1	3.522
Middle panel for height adjustable and standard counter (H740 mm)	BI3704193	2.620,00	1	2.620
Wooden front panel for square corner counter (H740 mm)	BI340346	4.878,00	1	4.878
Wooden side panel for info table (H740 mm)	BI38546	2.963,00	1	2.963
Steel leg frame for info table (H740 mm)	BI069146	2.855,00	1	2.855
Info table - end (H740 x W1240 mm)	BI28030543	6.581,00	1	6.581
Total price for configuration				92.450

Comments to configuration

- Monitor, chair and text are not included in price.
- All prices are based on colours and surfaces in price group A, see pages 4-7 for colours.
- We recommend the use of desk grommets, cable rails and drawer pedestals with the Inform counter, see page 113.

INFO TABLE

COUNTER TOPS WITH FOOT, SIDE PANEL AND LEG FRAME

As an adviser, you need to portray openness and show communicative skills. This also applies for the furniture. Our info table enlarges your work area with a short table element. It provides you with an open and informal space for small discussions.

Info table - starter

Foot included. Remember to order leg frame and wooden side panel.

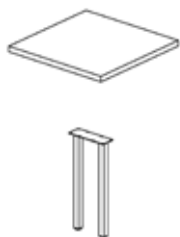

H x W x D mm	Item no. HPL	Price DKK
740 800 800	BI27010343	4.695
1000 800 800	BI27010363	4.875

Info table - end

Foot included. Remember to order leg frame and wooden side panel.

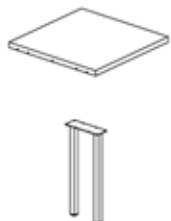

H x W x D mm	Item no. HPL	Price DKK
740 800 800	BI27030343	4.695
1000 800 800	BI27030363	4.875

Steel leg frame

Must be used when assembling 2 modules of the same height.

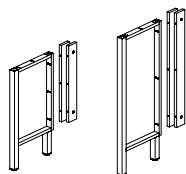

H mm	Item no. Melamine	Price DKK	Item no. Veneer	Price DKK
740	BI069146	2.855	BI069142	4.702
1000	BI069166	3.184	BI069162	5.244

Wooden side panel for info table

Used to create a finish on adjacent counter. Wooden side panel to be placed at the end of adjacent counter, with leg frame inside.

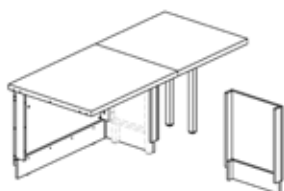

H x W x D mm	Item no. Melamine	Price DKK	Item no. Veneer	Price DKK
740 800 510	BI38546	2.963	BI38542	4.879
1000 800 510	BI38566	3.145	BI38562	5.180

INFO TABLE

COUNTER TOPS WITH PANEL, FRONT PANELS AND LEG FRAME

As an adviser, you need to portray openness and show communicative skills. This also applies for the furniture. Our info table enlarges your work area with a short table element. It provides you with an open and informal space for small discussions.

Info table - starter

Remember to order leg frame and wooden side panel for inside of adjacent counter.

H	x	W	x	D
mm				
740		840		800
740		1040		800
740		1240		800

Item no. HPL	Price DKK
BI28010343	5.716
BI28010443	6.366
BI28010543	6.581

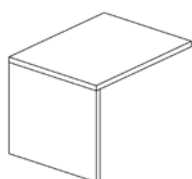

Info table - end

Remember to order leg frame and wooden side panel for inside of adjacent counter.

H	x	W	x	D
mm				
740		840		800
740		1040		800
740		1240		800

Item no. HPL	Price DKK
BI28030343	5.716
BI28030443	6.366
BI28030543	6.581

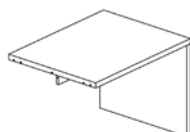

Steel leg frame for info table

Must be used when assembling 2 modules of the same height.

H mm	Item no. Melamine	Price DKK	Item no. Veneer	Price DKK
740	BI069146	2.855	BI069142	4.702

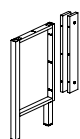

Wooden side panel for info table

Used to create a finish on adjacent counter. Wooden side panel to be placed at the end of adjacent counter with leg frame inside.

H	x	W	x	D	Item no. Melamine	Price DKK	Item no. Veneer	Price DKK
mm								
740		80		360	BI38546	2.963	BI38542	4.879

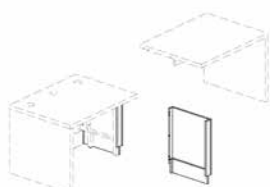

HEIGHT ADJUSTABLE COUNTER

CONFIGURATION NO. 7

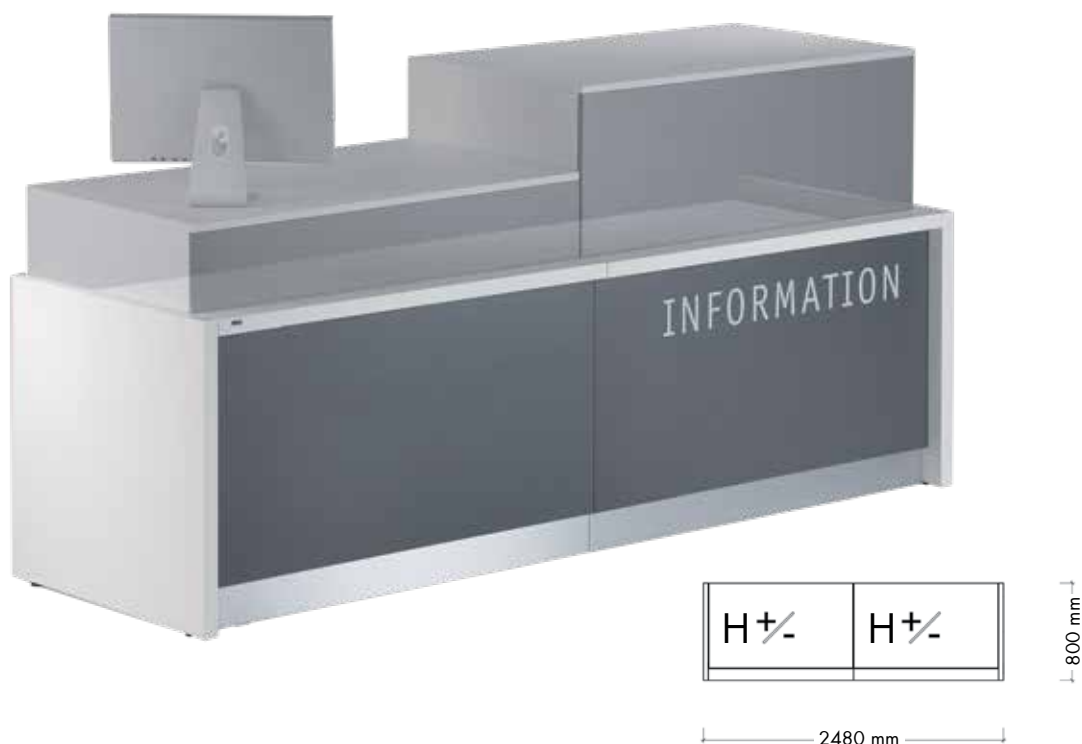

Rectangular height adjustable counters

Components	Article no.	Price DKK	Quantity	DKK
Left side panel for height adjustable counter (H740 mm)	BI3804303	2.345,00	1	2.345
Height adjustable counter - starter, middle and end (W1200 mm)	BI24015006	29.248,00	2	58.496
Wooden front panel for height adjustable counter (W1200 x H740 mm)	BI350546	4.095,00	2	8.190
Right side panel for height adjustable counter (H740 mm)	BI3804313	2.345,00	1	2.345
Total price for configuration				71.376

Comments to configuration

- Monitor and text are not included in price.
- All prices are based on colours and surfaces in price group A, see pages 4-7 for colours.
- We recommend the use of desk grommets, cable rails and drawer pedestals with the Inform counter, see page 113.

HEIGHT ADJUSTABLE COUNTER

CONFIGURATION NO. 8



Note: the front is flat

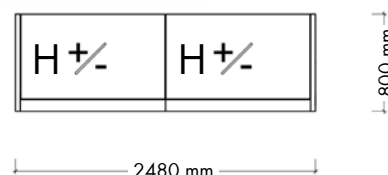

Rectangular height adjustable counters (with acrylic front)

Components	Article no.	Price DKK	Quantity	DKK
Left side panel for height adjustable counter (H740 mm)	BI3804303	2.345,00	1	2.345
Height adjustable counter - starter, middle and end (W1200 mm)	BI24015006	29.248,00	2	58.496
Acrylic front panel for height adjustable counter (W1200 x H740 mm)	BI360543	6.666,00	2	13.332
Right side panel for height adjustable counter (H740 mm)	BI3804313	2.345,00	1	2.345
Total price for configuration				76.518

Comments to configuration

- Text is not included in price.
- All prices are based on colours and surfaces in price group A, see pages 4-7 for colours.
- We recommend the use of desk grommets, cable rails and drawer pedestals with the Inform counter, see page 113.

HEIGHT ADJUSTABLE COUNTER

CONFIGURATION NO. 9

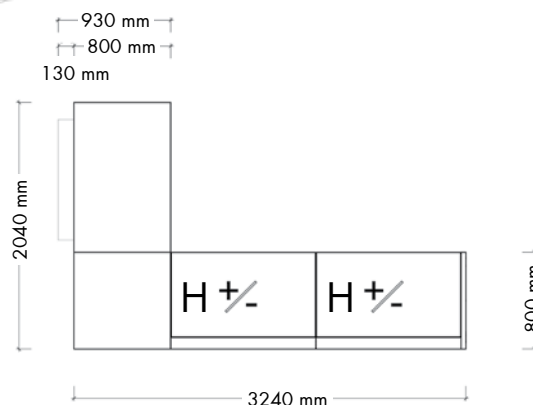

Rectangular height adjustable, corner and rectangular counters (with bag shelf)

Components	Article no.	Price DKK	Quantity	DKK
Left side panel for height adjustable counter (H740 mm)	BI3804303	2.345,00	1	2.345
Height adjustable counter - starter, middle and end (W1200 mm)	BI24015006	29.248,00	2	58.496
Wooden front panel for height adjustable counter (W1200 x H740 mm)	BI350546	4.095,00	2	8.190
Square corner counter top for height adjustable counter on left side	BI26520003	3.522,00	1	3.522
Middle panel for height adjustable and standard counter (H740 mm)	BI3704193	2.620,00	1	2.620
Wooden front panel for square corner counter (H740 mm)	BI340346	4.878,00	1	4.878
Rectangular counter - end (W1240 x H740 mm)	BI2003022003	5.995,00	1	5.995
Wooden front panel for rectangular counter (W1200 x H740 mm)	BI300546	2.368,00	1	2.368
Wooden bag shelf for rectangular counter (W1200 mm)	BI81053	1.535,00	1	1.535
Total price for configuration				89.949

Comments to configuration

- Monitor, office chairs and text are not included in price.
- All prices are based on colours and surfaces in price group A, see pages 4-7 for colours.
- We recommend the use of desk grommets, cable rails and drawer pedestals with the Inform counter, see page 113.
- The bag shelf is in fact 1000 mm long, adapted to a 1200 mm front panel.

HEIGHT ADJUSTABLE COUNTER

CONFIGURATION NO. 10

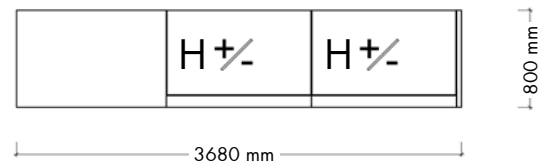

Rectangular height adjustable and rectangular counters (with bag shelves)

Components	Article no.	Price DKK	Quantity	DKK
Left side panel for height adjustable counter (H740 mm)	BI3804303	2.345,00	1	2.345
Height adjustable counter - starter, middle and end (W1200 mm)	BI24015006	29.248,00	2	58.496
Wooden front panel for height adjustable counter (W1200 x H740 mm)	BI350546	4.095,00	2	8.190
Middle panel for height adjustable and standard counter (H740 mm)	BI3704193	2.620,00	1	2.620
Rectangular counter for height adj. counter - end (W1240 x H740 mm)	BI2305022003	5.995,00	1	5.995
Wooden front panel for rectangular counter (W1200 x H740 mm)	BI300546	2.368,00	1	2.368
Wooden bag shelf for rectangular counter (W1200 mm)	BI81053	1.535,00	2	3.070
Total price for configuration				83.084

Comments to configuration

- Monitor, display and text are not included in price.
- All prices are based on colours and surfaces in price group A, see pages 4-7 for colours.
- We recommend the use of desk grommets, cable rails and drawer pedestals with the Inform counter, see page 113.
- The bag shelves are in fact 1000 mm long, adapted to 1200 mm front panels.

HEIGHT ADJUSTABLE COUNTER

RECTANGULAR COUNTERS

The height adjustable counter is a double construction with a moveable upper part and a fixed lower part. The moveable part of the counter slides along the walls of the fixed parts excluding possible safety risks such as entrapment and bruising. With the electrical driven height adjustable counter, you can adjust your working height ranging between 680 mm and 1180 mm. To construct a complete counter including a height adjustable counter, you must use the products shown on pages 72-81.

Height adjustable counter

Available in 3 versions:
 (1) for European market,
 (2) for US market 110V
 (3) for UK market.

Side, front and middle panels to be ordered separately. For counter with predrilled holes for cable conduct see pages 120-121.

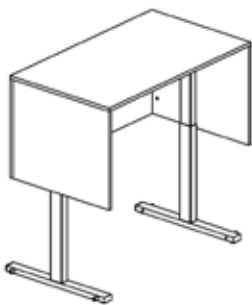

H	x	W	x	D	Item no. Melamine	Price DKK	Item no. Veneer	Price DKK
(1)	680-1180	1000		700	BI24014006	28.809	BI25014002	47.451
	680-1180	1200		700	BI24015006	29.248	BI25015002	48.175
	680-1180	1400		700	BI24016006	30.266	BI25016002	49.851
	680-1180	1600		700	BI24017006	30.610	BI25017002	50.417
(2)	680-1180	1000		700	BI24024006	28.809	BI25024002	47.451
	680-1180	1200		700	BI24025006	29.248	BI25025002	48.175
	680-1180	1400		700	BI24026006	30.266	BI25026002	49.851
	680-1180	1600		700	BI24027006	30.610	BI25027002	50.417
(3)	680-1180	1000		700	BI24034006	28.809	BI25034002	47.451
	680-1180	1200		700	BI24035006	29.248	BI25035002	48.175
	680-1180	1400		700	BI24036006	30.266	BI25036002	49.851
	680-1180	1600		700	BI24037006	30.610	BI25037002	50.417

Wooden front panel for height adjustable counter

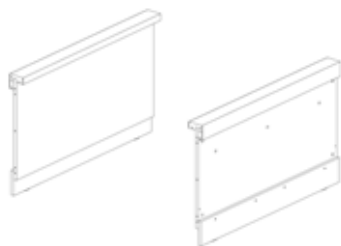

H	x	W	mm	Item no. Melamine	Price DKK	Item no. Veneer	Price DKK
740		1000		BI350446	3.837	BI350442	6.320
740		1200		BI350546	4.095	BI350542	6.745
740		1400		BI350646	4.318	BI350642	7.115
740		1600		BI350746	4.557	BI350742	7.504

Acrylic front panel for height adjustable counter

HPL wooden frame.



H	x	W	mm	Item no. Acrylic & HPL	Price DKK
740		1000		BI360443	6.186
740		1200		BI360543	6.666
740		1400		BI360643	7.363
740		1600		BI360743	8.087

HEIGHT ADJUSTABLE COUNTER

FRONT AND SIDE PANELS

Remember to order front and side panels for your height adjustable counter.

Side panel for height adjustable counter - for start/end

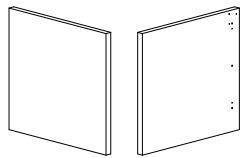
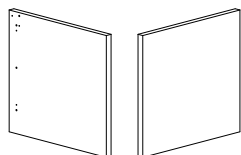
Side	H mm	Item no. HPL	Price DKK
 Left: No drill holes Right: Height adjustable counter	740	BI3804303	2.345
 Left: Height adjustable counter Right: No drill holes	740	BI3804313	2.345

HEIGHT ADJUSTABLE COUNTER

H740 MM RECTANGULAR COUNTERS FOR HEIGHT ADJUSTABLE COUNTER

If you wish to add a rectangular H740 mm counter to Inform height adjustable counters, you must use the counters shown below. If you wish to add a rectangular H1000 mm counter, see page 22. See overview on page 82 to find the correct middle panel for your construction.

H740 mm rectangular counter for right sided height adjustable counter - starter

Left side: Starter Right side: Height adjustable Use with middle panel BI3704193, see page 82. Remember to order front panel, see next page. For counters with predrilled holes for cable conduct, see pages 120-121.	H x W x D mm	Item no. HPL	Price DKK
	740 640 800	BI2301016003	5.093
	740 840 800	BI2301018003	5.273
	740 1040 800	BI2301020003	5.634
	740 1240 800	BI2301022003	5.995
	740 1440 800	BI2301024003	6.444
	740 1640 800	BI2301026003	6.716

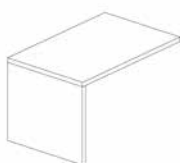

H740 mm rectangular counter for right sided height adjustable counter - middle

Left side: Rectangular/curved/corner Right side: Height adjustable Use with middle panel BI3704193, see page 82. Remember to order front panel, see next page. For counters with predrilled holes for cable conduct, see pages 120-121.	H x W x D mm	Item no. HPL	Price DKK
	740 640 800	BI2302060003	2.657
	740 840 800	BI2302080003	2.836
	740 1040 800	BI2302081003	3.199
	740 1240 800	BI2302082003	3.560
	740 1440 800	BI2302084003	4.010
	740 1640 800	BI2302086003	4.281



H740 mm rectangular counter for height adjustable counter on both sides

Left side: Height adjustable Right side: Height adjustable Use with two middle panels BI3704183 and BI3704193, see page 82. Remem- ber to order front panel, see next page. For counters with predrilled holes for cable conduct, see pages 120-121.	H x W x D mm	Item no. HPL	Price DKK
	740 600 800	BI2303060003	2.657
	740 800 800	BI2303080003	2.836
	740 1000 800	BI2303081003	3.199
	740 1200 800	BI2303082003	3.560
	740 1400 800	BI2303084003	4.010
	740 1600 800	BI2303086003	4.281



HEIGHT ADJUSTABLE COUNTER

H740 MM RECTANGULAR COUNTERS AND FRONTS FOR HEIGHT ADJUSTABLE COUNTER

If you wish to add a rectangular H740 mm counter to Inform height adjustable counters, you must use the counters shown below. If you wish to add a rectangular H1000 mm counter, see page 22. See overview on page 82 to find the correct middle panel for your construction.

H740 mm rectangular counter for left sided height adjustable counter - middle

Left side: Height adjustable Right side: Rectangular/curved/corner Use with middle panel BI3704183, see page 82. Remember to order front panel, see below. For counters with predrilled holes for cable conduct, see pages 120-121.	H x W x D mm	Item no. HPL	Price DKK
	740 600 800	BI2304060003	2.657
	740 800 800	BI2304080003	2.836
	740 1000 800	BI2304081003	3.199
	740 1200 800	BI2304082003	3.560
	740 1400 800	BI2304084003	4.010
	740 1600 800	BI2304086003	4.281



H740 mm rectangular counter for left sided height adjustable counter - end

Left side: Height adjustable Right side: End Use with middle panel BI3704183, see page 82. Remember to order front panel, see below. For counters with predrilled holes for cable conduct, see pages 120-121.	H x W x D mm	Item no. HPL	Price DKK
	740 640 800	BI2305016003	5.093
	740 840 800	BI2305018003	5.273
	740 1040 800	BI2305020003	5.634
	740 1240 800	BI2305022003	5.995
	740 1440 800	BI2305024003	6.444
	740 1640 800	BI2305026003	6.716

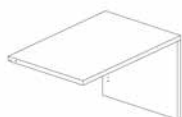

Wooden or acrylic front panel for rectangular counter for height adjustable counter

Wooden: Melaminecoated/veneer. Acrylic: Melaminecoated wooden frame.	H x W mm	Item no. Melamine/veneer	Price DKK	Item no. Acrylic & melamine	Price DKK
	740 600	BI300146	1.543	BI310146	5.790
	740 800	BI300346	1.773	BI310346	5.962
	740 1000	BI300446	2.135	BI310446	6.667
	740 1200	BI300546	2.368	BI310546	7.016
	740 1400	BI300646	2.623	BI310646	7.542
	740 1600	BI300746	3.020	BI310746	8.054
	740 600	BI300142	2.541		
	740 800	BI300342	2.924		
	740 1000	BI300442	3.517		
	740 1200	BI300542	3.900		
	740 1400	BI300642	4.318		
	740 1600	BI300742	4.972		

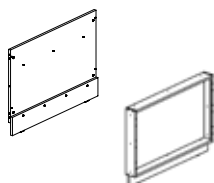

HEIGHT ADJUSTABLE COUNTER

H740 MM 45° CURVED COUNTERS FOR HEIGHT ADJUSTABLE COUNTER

If you wish to add a 45° curved H740 mm counter to Inform height adjustable counters, you must use the counters shown below. If you wish to add a 45° curved H1000 mm counter, see page 24. See overview on page 82 to find the correct middle panel for your construction.

45° curved counter for right sided height adjustable counter - starter

Left side: Starter Right side: Height adjustable Use with middle panel BI3704193, see page 82. Remember to order front panel, see next page. For counters with predrilled holes for cable conduct, see pages 120-121.	H x W x D mm	Item no. HPL	Price DKK
	740 1835 800	BI2351428003	9.243

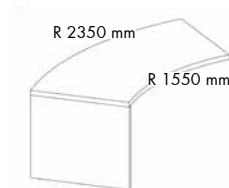

45° curved counter for right sided height adjustable counter - middle

Left side: Rectangular/curved/corner Right side: Height adjustable Use with middle panel BI3704193, see page 82. Remember to order front panel, see next page. For counters with predrilled holes for cable conduct, see pages 120-121.	H x W x D mm	Item no. HPL	Price DKK
	740 1800 800	BI2352488003	6.808



45° curved counter for height adjustable counter on both sides

Left side: Height adjustable Right side: Height adjustable Use with two middle panels BI3704183 and BI3704193, see page 82. Remem- ber to order front panel, see next page. For counters with predrilled holes for cable conduct, see pages 120-121.	H x W x D mm	Item no. HPL	Price DKK
	740 1800 800	BI2353488003	9.243



HEIGHT ADJUSTABLE COUNTER

H740 MM 45° CURVED COUNTERS AND FRONT PANELS FOR HEIGHT ADJUSTABLE COUNTER

If you wish to add a 45° curved H740 mm counter to Inform height adjustable counters, you must use the counters shown below. If you wish to add a 45° curved H1000 mm counter, see page 24. See overview on page 82 to find the correct middle panel for your construction.

45° curved counter for left sided height adjustable counter - middle

Left side: Height adjustable Right side: Rectangular/curved/corner Use with middle panel BI3704183, see page 82. Remember to order front panel, see below. For counters with predrilled holes for cable conduct, see pages 120-121.	H x W x D mm	Item no. HPL	Price DKK
	740 1800 800	BI2354488003	6.808



45° curved counter for left sided height adjustable counter - end

Left side: Height adjustable Right side: End Use with middle panel BI3704183, see page 82. Remember to order front panel, see below. For counters with predrilled holes for cable conduct, see pages 120-121.	H x W x D mm	Item no. HPL	Price DKK
	740 1835 800	BI2355428003	9.243

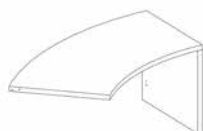

Wooden or acrylic front panel for 45° curved counter

Wooden: High pressure laminate (HPL) Acrylic: Melaminecoated wooden frame.	H x W mm	Item no. HPL	Price DKK	Item no. Acrylic & melamine	Price DKK
	740 1760	BI3204543	15.820	BI3304546	11.351

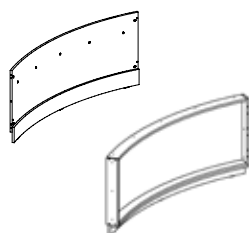

HEIGHT ADJUSTABLE COUNTER

H740 MM 90° CURVED COUNTERS FOR HEIGHT ADJUSTABLE COUNTER

If you wish to add a 90° curved H740 mm counter to Inform height adjustable counters, you must use the counters shown below. If you wish to add a 90° curved H1000 mm counter, see page 26. See overview on page 82 to find the correct middle panel for your construction.

90° curved counter for right sided height adjustable counter - starter

Left side: Starter Right side: Height adjustable Use with middle panel BI3704193, see page 82. Remember to order front panel, see next page. For counters with predrilled holes for cable conduct, see pages 120-121.	H x W x D mm	Item no. HPL	Price DKK
	740 1870 800	BI2351928003	9.966

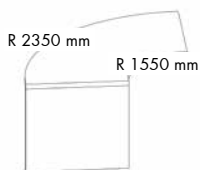

90° curved counter for right sided height adjustable counter - middle

Left side: Rectangular/curved/corner Right side: Height adjustable Use with middle panel BI3704193, see page 82. Remember to order front panel, see next page. For counters with predrilled holes for cable conduct, see pages 120-121.	H x W x D mm	Item no. HPL	Price DKK
	740 1840 800	BI2352988003	7.531



90° curved counter for height adjustable counter on both sides

Left side: Height adjustable Right side: Height adjustable Use with two middle panels BI3704183 and BI3704193, see page 82. Remem- ber to order front panel, see next page. For counters with predrilled holes for cable conduct, see pages 120-121.	H x W x D mm	Item no. HPL	Price DKK
	740 1840 800	BI2353988003	9.966



HEIGHT ADJUSTABLE COUNTER

H740 MM 90° CURVED COUNTERS AND FRONT PANELS FOR HEIGHT ADJUSTABLE COUNTER

If you wish to add a 90° curved H740 mm counter to Inform height adjustable counters, you must use the counters shown below. If you wish to add a 90° curved H1000 mm counter, see page 26. See overview on page 82 to find the correct middle panel for your construction.

90° curved counter for left sided height adjustable counter - middle

Left side: Height adjustable Right side: Rectangular/curved/corner Use with middle panel BI3704183, see page 82. Remember to order front panel, see below. For counters with predrilled holes for cable conduct, see pages 120-121.	H x W x D mm	Item no. HPL	Price DKK
	740 1840 800	BI2354988003	7.531

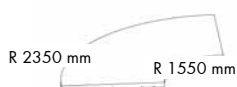

90° curved counter for left sided height adjustable counter - end

Left side: Height adjustable Right side: End Use with middle panel BI3704183, see page 82. Remember to order front panel, see below. For counters with predrilled holes for cable conduct, see pages 120-121.	H x W x D mm	Item no. HPL	Price DKK
	740 1870 800	BI2355928003	9.966



Wooden or acrylic front panel for 90° curved counter

Wooden: High pressure laminate (HPL) Acrylic: Melamincoated wooden frame.	H x W mm	Item no. HPL	Price DKK	Item no. Acrylic & melamine	Price DKK
	740 1768	BI3209043	16.087	BI3309066	15.594

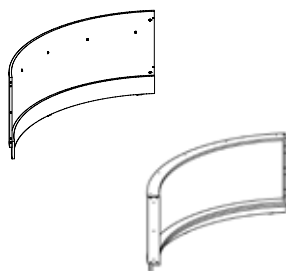

HEIGHT ADJUSTABLE COUNTER

H740 MM 45° CURVED COUNTERS FOR HEIGHT ADJUSTABLE AND RECESSED COUNTER

If you wish to place a 45° curved H740 mm counter in between a height adjustable counter and a recessed counter, you must use the counters shown below.

45° curved counter for right sided height adjustable counter - middle

Left side: Recessed - use with middle panel BI3704103.	H x W x D mm	Item no. HPL	Price DKK
Right side: Height adjustable - use with middle panel BI3704183. Remember to order front panel, see below. For counters with predrilled holes for cable conduct, see pages 120-121.	740 xx 800	BI2362488003	6.808

45° curved counter for left sided height adjustable counter - middle

Left side: Height adjustable - use with middle panel BI3704183.	H x W x D mm	Item no. HPL	Price DKK
Right side: Recessed - use with middle panel BI3704103. Remember to order front panel, see below. For counters with predrilled holes for cable conduct, see pages 120-121.	740 xx 800	BI2364488003	6.808

Wooden or acrylic front panel for 45° curved counter

Wooden: High pressure laminate (HPL) Acrylic: Melaminecoated wooden frame.	H x W mm	Item no. HPL	Price DKK	Item no. Acrylic & melamine	Price DKK
	740 1760	BI3204543	15.820	BI3304546	11.351

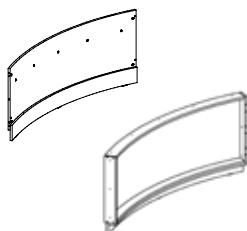

HEIGHT ADJUSTABLE COUNTER

H740 MM 90° CURVED COUNTERS PANELS FOR HEIGHT ADJUSTABLE AND RECESSED COUNTER

If you wish to place a 90° curved H740 mm counter in between a height adjustable counter and a recessed counter, you must use the counters shown below.

90° curved counter for right sided height adjustable counter - middle

Left side: Recessed - use with middle panel BI3704103.	H x W x D mm	Item no. HPL	Price DKK
Right side: Height adjustable - use with middle panel BI3704183. Remember to order front panel, see below. For counters with predrilled holes for cable conduct, see pages 120-121.	740 xx 800	BI2362988003	7.531

90° curved counter for left sided height adjustable counter - middle

Left side: Height adjustable - use with middle panel BI3704183.	H x W x D mm	Item no. HPL	Price DKK
Right side: Recessed - use with middle panel BI3704103. Remember to order front panel, see below. For counters with predrilled holes for cable conduct, see pages 120-121.	740 xx 800	BI2364988003	7.531

Wooden or acrylic front panel for 90° curved counter

Wooden: High pressure laminate (HPL) Acrylic: Melaminecoated wooden frame.	H x W mm	Item no. HPL	Price DKK	Item no. Acrylic & melamine	Price DKK
	740 1768	BI3209043	16.087	BI3309066	15.594

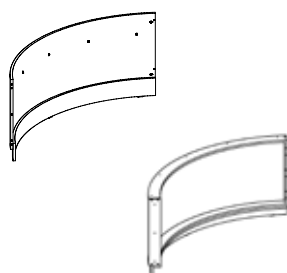

HEIGHT ADJUSTABLE COUNTER

SQUARE CORNER COUNTER FOR HEIGHT ADJUSTABLE COUNTER

If you wish to add a square corner counter to Inform height adjustable counters, you must use the counters shown below. See overview on page 82 to find the correct middle panel for your construction.

Square corner counter top for right sided height adjustable counter

Left side: Rectangular	H x W x D	Item no.	Price
Right side: Height adjustable	mm	HPL	DKK
Use with middle panel BI3704193, see page 82. Remember to order front panel, see below. For counters with predrilled holes for cable conduct, see pages 108- 109.	740 800 800	BI26510003	3.522



Square corner counter top for left sided height adjustable counter

Left side: Height adjustable	H x W x D	Item no.	Price
Right side: Rectangular	mm	HPL	DKK
Use with middle panel BI3704183, see page 82. Remember to order front panel, see below. For counters with predrilled holes for cable conduct, see pages 120-121.	740 800 800	BI26520003	3.522



Wooden front panel for square corner counter

H x W x D	Item no.	Price	Item no.	Price
mm	Melamine	DKK	Veneer	DKK
740 800 800	BI340346	4.878	BI340342	8.035

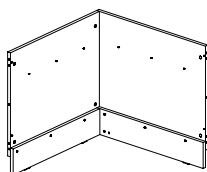

HEIGHT ADJUSTABLE COUNTER

TRIANGULAR CORNER COUNTER FOR HEIGHT ADJUSTABLE COUNTER

If you wish to add a triangular corner counter to Inform height adjustable counters, you must use the counters shown below. See overview on page 82 to find the correct middle panel for your construction.

Triangular corner counter top for right sided height adjustable counter

Left side: Rectangular Right side: Height adjustable Use with middle panel BI3704193 (see page 82. Remember to order front panel, see below. For counters with predrilled holes for cable conduct, see pages 120-121.	H x W x D mm	Item no. HPL	Price DKK
	740 800 800	BI26813003	3.804

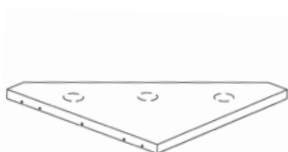

Triangular corner counter top for left sided height adjustable counter

Left side: Height adjustable Right side: Rectangular Use with middle panel BI3704183, see page 82. Remember to order front panel, see below. For counters with predrilled holes for cable conduct, see pages 120-121.	H x W x D mm	Item no. HPL	Price DKK
	740 800 800	BI26823003	3.804

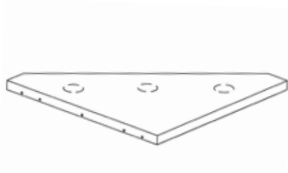

Wooden front panel for triangular corner counter

Remember to order leg frame.	H x W x D mm	Item no. Melamine	Price DKK	Item no. Veneer	Price DKK
	740 800 800	BI345346	3.562	BI345342	5.865

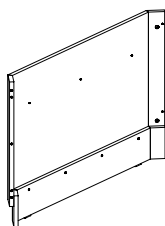

HEIGHT ADJUSTABLE COUNTERS

MIDDLE PANELS

It is necessary to order side and middle panels for the height adjustable counter BI240, depending on the construction of your complete counter. See overview of middle panels below. Note - do not place more than 2 height adjustable counters next to each other and remember always to construct your counter from left to right when sitting behind the counter.

Middle panel for height adjustable and rectangular/curved/corner counters, see pages 72-79

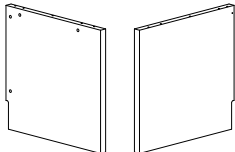
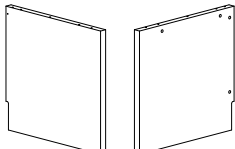
Side of panel	H mm	Item no. HPL	Price DKK
 <p>Left: H740 mm rectangular/curved/corner for height adjustable counter Right: Height adjustable counter</p>	740	BI3704183	2.620
 <p>Left: Height adjustable counter Right: H740 mm rectangular/curved/corner for height adjustable counter</p>	740	BI3704193	2.620

Middle panel for height adjustable and recessed counter, see pages 38-50

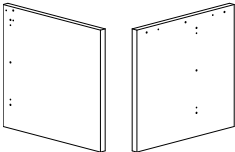
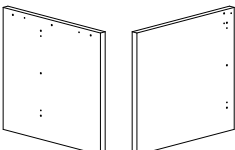
Side of panel	H mm	Item no. HPL	Price DKK
 <p>Left: Height adjustable counter Right: Recessed counter</p>	740	BI3704163	1.281
 <p>Left: Recessed counter Right: Height adjustable counter</p>	740	BI3704173	1.281

Middle panel for height adjustable and step counter, see pages 54-56

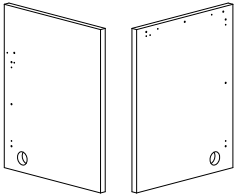
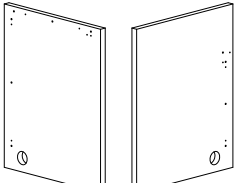
Side of panel	H mm	Item no. HPL	Price DKK
 <p>Left: Height adjustable counter Right: Rectangular/step counter (1000 mm)</p>	1000	BI3706203	2.620
 <p>Left: Rectangular/step counter (1000 mm) Right: Height adjustable counter</p>	1000	BI3706213	2.620

HEIGHT ADJUSTABLE COUNTER

CONFIGURATIONS

It is necessary to order side and middle panels for the height adjustable counter BI240, depending on the construction of your complete counter. See overview of middle panels on page 82. Note - do not place more than 2 height adjustable counters next to each other and remember always to construct your counter from left to right when sitting behind the counter.

Rectangular and height adjustable counter

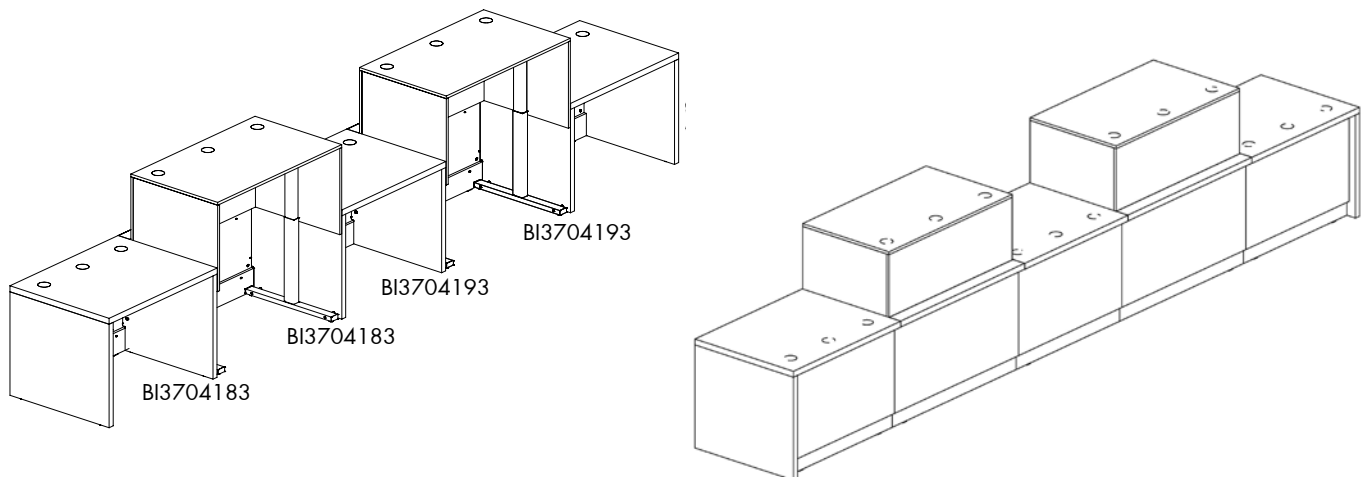

Recessed rectangular and height adjustable counter

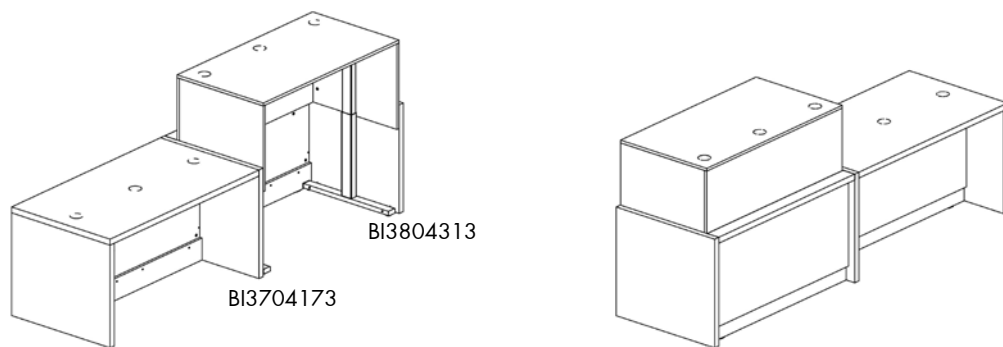

Special rectangular, height adjustable, corner and info counters

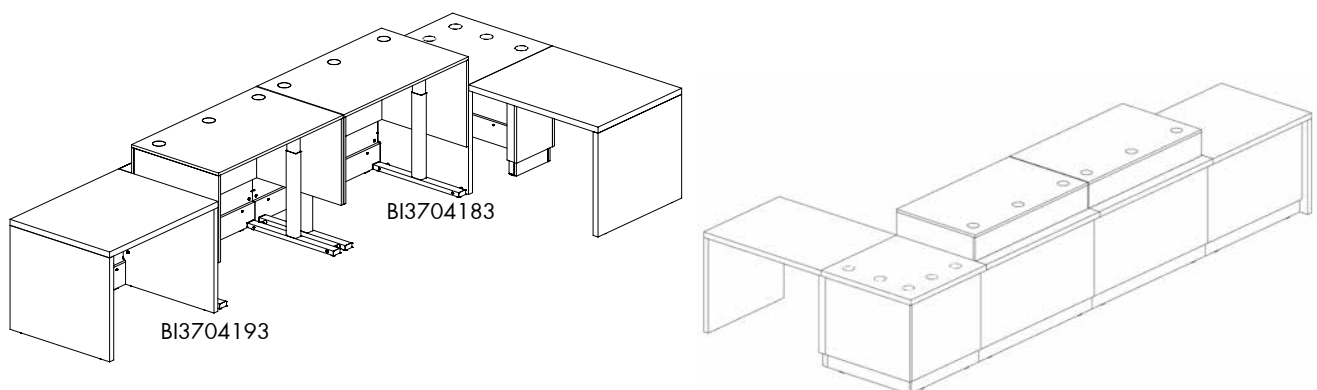

COUNTER SHELF

STANDARD AND SPECIAL SOLUTIONS

COUNTER SHELVES FOR VARIOUS COUNTERS

When ordering freestanding counter shelf for your counter, please note the following:

A freestanding counter shelf has (equal to a freestanding counter) 40 mm end panels on both sides. The front of the counter shelf has the same measurement as the counter below. This means that if you place a freestanding counter shelf (with two end panels) on a counter built up of two modules, the end panel of the counter shelf will be placed on the top of the adjacent counter.

It is possible to construct a freestanding counter shelf that fits on the counters below, (see 3 options below), but this must be specially requested. Contact customer service for details.

STANDARD

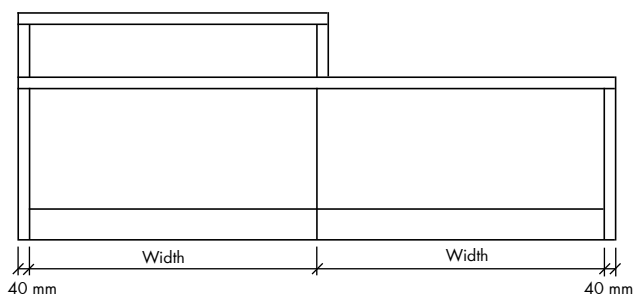

SPECIAL SOLUTION 1

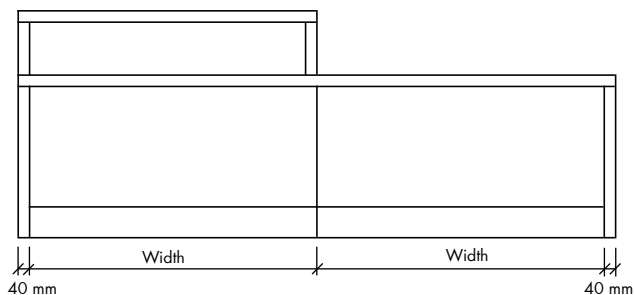

SPECIAL SOLUTION 2

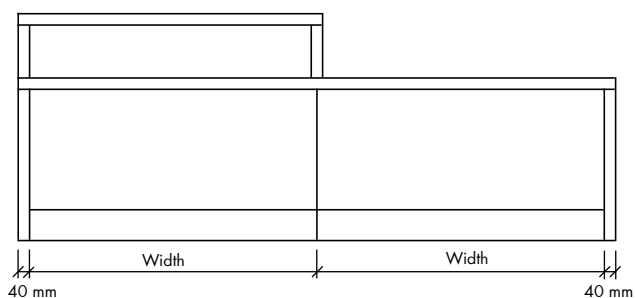

SPECIAL SOLUTION 3

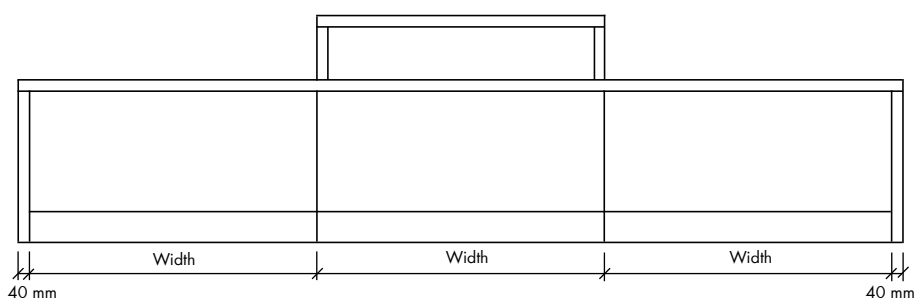

COUNTER SHELF

CONFIGURATION NO. 15



Rectangular & square corner counters (with counter shelves and bag shelves)

Components	Article no.	Price DKK	Quantity	DKK
Rectangular counter - starter (W1240 x H740 mm)	BI2001022003	5.995,00	1	5.995
Rectangular counter - middle (W1200 x H740 mm)	BI2002082003	3.740,00	1	3.740
Rectangular counter - end (W1240 x H740 mm)	BI2003022003	5.995,00	1	5.995
Square corner counter top (H740 mm)	BI26530003	3.427,00	1	3.427
Wooden front panel for rectangular counter (W1200 x H740 mm)	BI300546	2.368,00	2	4.736
Acrylic front panel for rectangular counter (W1200 x H740 mm)	BI310546	7.016,00	1	7.016
Wooden front panel for square corner counter (H740 mm)	BI340346	4.878,00	1	4.878
Wooden bag shelf for rectangular counter (W1200 mm)	BI81053	1.535,00	2	3.070
Counter shelf and front for rectangular counter - starter (W1240 mm)	BI4101056	3.842,00	1	3.842
Counter shelf and front for rectangular counter - end (W1240 mm)	BI4103056	3.842,00	1	3.842
Steel leg frame (H740 mm)	BI069146	2.855,00	3	8.565
Total price for configuration				55.106

Comments to configuration

- Office chair, monitors, Puppy and text are not included in price.
- All prices are based on colours and surfaces in price group A, see pages 4-7 for colours.
- We recommend the use of desk grommets, cable rails and drawer pedestals with the Inform counter, see page 113.
- The bag shelf is in fact 1000 mm long, adapted to a 1200 mm front panel.

COUNTER SHELF

CONFIGURATION NO. 16

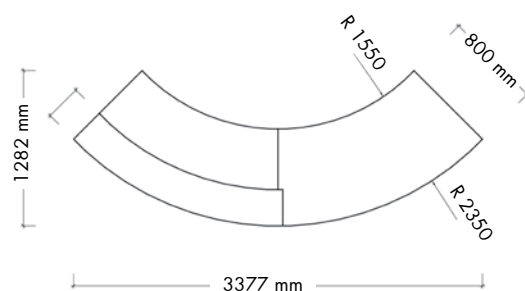

45° curved counters (with counter shelf)

Components	Article no.	Price DKK	Quantity	DKK
45° curved counter - starter (H740 mm)	BI2051428003	9.243,00	1	9.243
45° curved counter - end (H740 mm)	BI2053428003	9.243,00	1	9.243
Wooden front panel for 45° curved counter (H740 mm)	BI3204543	15.820,00	2	31.640
Steel leg frame (H740 mm)	BI069146	2.855,00	1	2.855
Counter shelf with front panel for 45° counter - freestanding	BI431443	10.317,00	1	10.317
Total price for configuration				63.298

Comments to configuration

- Monitor and text are not included in price.
- All prices are based on colours and surfaces in price group A, see pages 4-7 for colours.
- We recommend the use of desk grommets, cable rails and drawer pedestals with the Inform counter, see page 113.

COUNTER SHELF

CONFIGURATION NO. 17

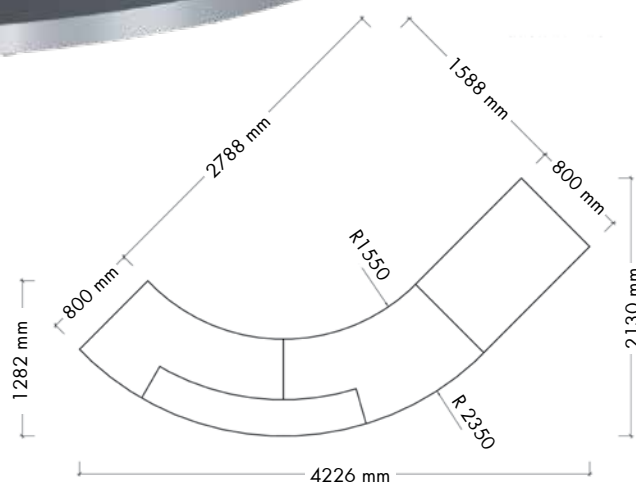

45° curved and rectangular counters (with counter shelf)

Components	Article no.	Price DKK	Quantity	DKK
Rectangular counter - starter (W1240 x H740 mm)	BI2001022003	5.995,00	1	5.995
45° curved counter - middle (H740 mm)	BI2052488003	6.808,00	1	6.808
45° curved counter - end (H740 mm)	BI2053428003	9.243,00	1	9.243
Wooden front panel for rectangular counter (W1200 x H740 mm)	BI300546	2.368,00	1	2.368
Wooden front panel for 45° curved counter (H740 mm)	BI3204543	15.820,00	2	31.640
Steel leg frame (H740 mm)	BI069146	2.855,00	2	5.710
Counter shelf with front panel for 45° counter - freestanding	BI431443	10.317,00	1	10.317
Total price for configuration				72.081

Comments to configuration

- Monitor and text are not included in price.
- All prices are based on colours and surfaces in price group A, see pages 4-7 for colours.
- We recommend the use of desk grommets, cable rails and drawer pedestals with the Inform counter, see page 113.

COUNTER SHELF

COUNTER SHELVES FOR RECTANGULAR COUNTERS

Create a private working space by adding a counter shelf to your standard rectangular counter. It has both practical and optical advantages.

Wooden counter shelf with front panel for rectangular counter - starter

High pressure laminate (HPL) counter shelf and melamine coated/veneer front panel.

H x W x D mm	Item no. HPL & melamine	Price DKK	Item no. HPL & veneer	Price DKK
260 640 300	BI4101016	3.127	BI4151012	5.151
260 840 300	BI4101036	3.299	BI4151032	5.436
260 1040 300	BI4101046	3.661	BI4151042	6.031
260 1240 300	BI4101056	3.842	BI4151052	6.327
260 1440 300	BI4101066	4.023	BI4151062	6.626
260 1640 300	BI4101076	4.292	BI4151072	7.068

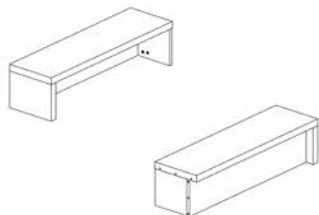

Wooden counter shelf with front panel for rectangular counter - middle

High pressure laminate (HPL) counter shelf and melamine coated/veneer front panel.

H x W x D mm	Item no. HPL & melamine	Price DKK	Item no. HPL & veneer	Price DKK
260 640 300	BI4102016	3.127	BI4152012	5.151
260 840 300	BI4102036	3.299	BI4152032	5.436
260 1040 300	BI4102046	3.661	BI4152042	6.031
260 1240 300	BI4102056	3.842	BI4152052	6.327
260 1440 300	BI4102066	4.023	BI4152062	6.626
260 1640 300	BI4102076	4.292	BI4152072	7.068

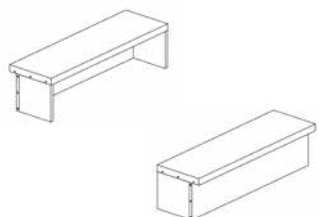

Wooden counter shelf with front panel for rectangular counter - end

High pressure laminate (HPL) counter shelf and melamine coated/veneer front panel.

H x W x D mm	Item no. HPL & melamine	Price DKK	Item no. HPL & veneer	Price DKK
260 640 300	BI4103016	3.127	BI4153012	5.151
260 840 300	BI4103036	3.299	BI4153032	5.436
260 1040 300	BI4103046	3.661	BI4153042	6.031
260 1240 300	BI4103056	3.842	BI4153052	6.327
260 1440 300	BI4103066	4.023	BI4153062	6.626
260 1640 300	BI4103076	4.292	BI4153072	5.891

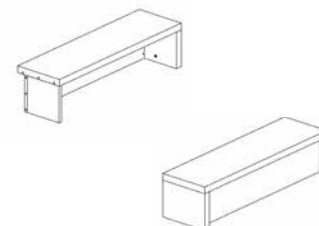

Wooden counter shelf with front panel for rectangular counter - freestanding

High pressure laminate (HPL) counter shelf and melamine coated/veneer front panel.

H x W x D mm	Item no. HPL & melamine	Price DKK	Item no. HPL & veneer	Price DKK
260 680 300	BI4104016	3.127	BI4154012	5.151
260 880 300	BI4104036	3.299	BI4154032	5.436
260 1080 300	BI4104046	3.661	BI4154042	6.031
260 1280 300	BI4104056	3.842	BI4154052	6.327
260 1480 300	BI4104066	4.023	BI4154062	6.626
260 1680 300	BI4104076	4.292	BI4154072	7.068

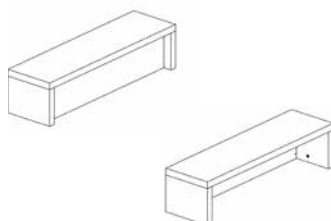

COUNTER SHELF

COUNTER SHELVES FOR CORNER COUNTERS

Create a private working space by adding a counter shelf to your standard corner counter. It has both practical and optical advantages.

Wooden counter shelf with front panel for corner counter - starter

High pressure laminate (HPL) counter shelf and melamine coated/veneer front panel.	H x W x D mm	Item no. HPL & melamine	Price DKK	Item no. HPL & veneer	Price DKK
	260 800 300	BI4201036	5.592	BI4251032	9.210

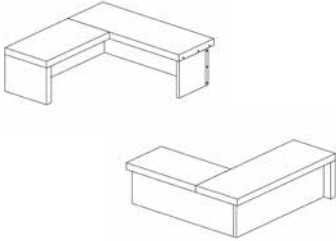

Wooden counter shelf with front panel for corner counter - middle

High pressure laminate (HPL) counter shelf and melamine coated/veneer front panel.	H x W x D mm	Item no. HPL & melamine	Price DKK	Item no. HPL & veneer	Price DKK
	260 800 300	BI4202036	5.592	BI4252032	9.210

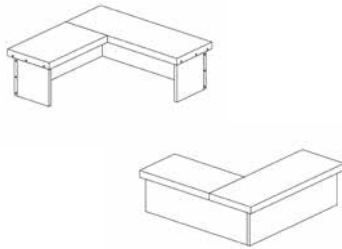

Wooden counter shelf with front panel for corner counter - end

High pressure laminate (HPL) counter shelf and melamine coated/veneer front panel.	H x W x D mm	Item no. HPL & melamine	Price DKK	Item no. HPL & veneer	Price DKK
	260 800 300	BI4203036	5.592	BI4253032	9.210

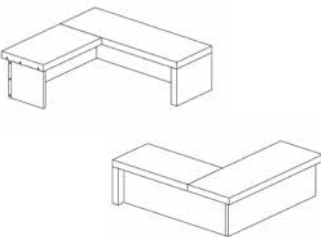

Wooden counter shelf with front panel for corner counter - freestanding

High pressure laminate (HPL) counter shelf and melamine coated/veneer front panel.	H x W x D mm	Item no. HPL & melamine	Price DKK	Item no. HPL & veneer	Price DKK
	260 800 300	BI4204036	5.592	BI4254032	9.210

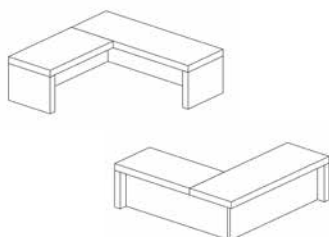

COUNTER SHELF

COUNTER SHELVES FOR 45° COUNTER

Create a private working space by adding a counter shelf to your curved counter. It has both practical and optical advantages.

Wooden counter shelf with front panel for 45° counter - starter

High pressure laminate (HPL) counter shelf and HPL/veneer front panel.	H x D mm	Item no. HPL	Price DKK	Item no. HPL & veneer	Price DKK
	260 300	BI431143	10.317	BI435142	12.380

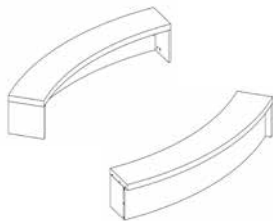

Wooden counter shelf with front panel for 45° counter - middle

High pressure laminate (HPL) counter shelf and HPL/veneer front panel.	H x D mm	Item no. HPL	Price DKK	Item no. HPL & veneer	Price DKK
	260 300	BI431243	10.317	BI435242	12.380

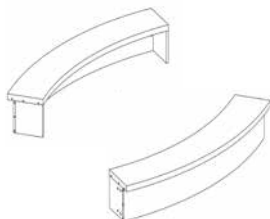

Wooden counter shelf with front panel for 45° counter - end

High pressure laminate (HPL) counter shelf and HPL/veneer front panel.	H x D mm	Item no. HPL	Price DKK	Item no. HPL & veneer	Price DKK
	260 300	BI431343	10.317	BI435342	12.380

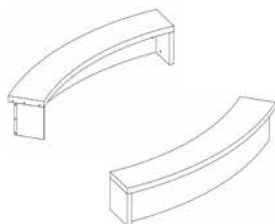

Wooden counter shelf with front panel for 45° counter - freestanding

High pressure laminate (HPL) counter shelf and HPL/veneer front panel.	H x D mm	Item no. HPL	Price DKK	Item no. HPL & veneer	Price DKK
	260 300	BI431443	10.317	BI435442	12.380

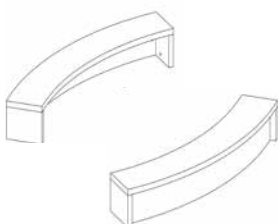

COUNTER SHELF

COUNTER SHELVES FOR 90° COUNTER

Create a private working space by adding a counter shelf to your curved counter. It has both practical and optical advantages.

Wooden counter shelf with front panel for 90° counter- starter

High pressure laminate (HPL) counter shelf and HPL/veneer front panel.	H x D mm	Item no. HPL	Price DKK	Item no. HPL & veneer	Price DKK
	260 300	BI431193	10.317	BI435192	12.380

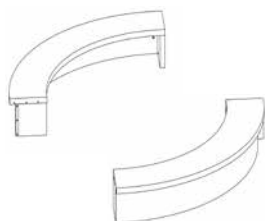

Wooden counter shelf with front panel for 90° counter - middle

High pressure laminate (HPL) counter shelf and HPL/veneer front panel.	H x D mm	Item no. HPL	Price DKK	Item no. HPL & veneer	Price DKK
	260 300	BI431293	10.317	BI435292	12.380

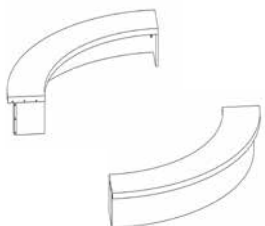

Wooden counter shelf with front panel for 90° counter - end

High pressure laminate (HPL) counter shelf and HPL/veneer front panel.	H x D mm	Item no. HPL	Price DKK	Item no. HPL & veneer	Price DKK
	260 300	BI431393	10.317	BI435392	12.380

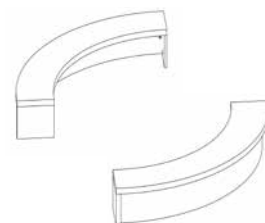

Wooden counter shelf with front panel for 90° counter - freestanding

High pressure laminate (HPL) counter shelf and HPL/veneer front panel.	H x D mm	Item no. HPL	Price DKK	Item no. HPL & veneer	Price DKK
	260 300	BI431493	10.317	BI435492	12.380

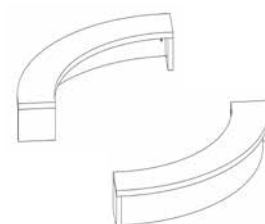

DISPLAY AND STORAGE

CONFIGURATION NO. 18

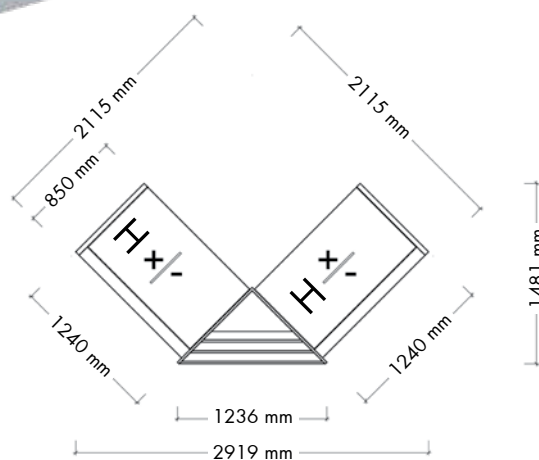

Rectangular height adjustable counters and corner display unit

Components	Article no.	Price DKK	Quantity	DKK
Left side panel for height adjustable counter (H740 mm)	BI3804303	2.345,00	1	2.345
Height adjustable counter - starter, middle and end (W1200 mm)	BI24015006	29.248,00	2	58.496
Acrylic front panel for height adjustable counter (W1200 x H740 mm)	BI360543	6.666,00	2	13.332
Corner display unit (H870 mm)	BI5105336	17.592,00	1	17.592
Right side panel for height adjustable counter (H740 mm)	BI3804313	2.345,00	1	2.345
Total price for configuration				94.110

Comments to configuration

- Monitor, display and text are not included in price.
- All prices are based on colours and surfaces in price group A, see pages 4-7 for colours.
- We recommend the use of desk grommets, cable rails and drawer pedestals with the Inform counter, see page 113.

DISPLAY AND STORAGE

CORNER DISPLAY UNITS

This is a slender corner solution with a presentation function towards the customer. The front-side shelves provide perfect storage for loose pamphlets, as well as for books and DVD's. The display unit also structures your counter and offers space e.g. book stands at standing height. The display units are ready for direct integration into all parts of the Inform counter. When constructing your counter, remember always to construct your counter from left to right when sitting behind the counter!

H870 mm - corner display unit

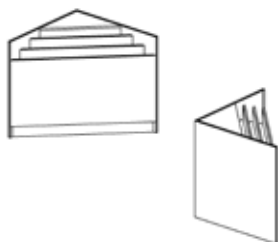

H	x	W	x	Front	Item no.	Price	Item no.	Price
		mm			Melamine	DKK	Veneer	DKK
870	875	1200			BI5105006	17.433	BI5105002	28.715

To have the correct positioning of drill holes in combination with other counters or cabinets, you must use the following in the article number:

		Left panel	Right panel
No drill holes for connecting fittings	BI5105	0	0
Drill holes for counter height 740 mm	BI5105	2	2
Drill holes for height adjustable counter	BI5105	3	3
Drill holes for recessed counter	BI5105	4	4

H1130 mm - corner display unit

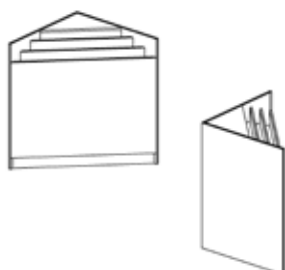

H	x	W	x	Front	Item no.	Price	Item no.	Price
		mm			Melamine	DKK	Veneer	DKK
1130	875	1200			BI5107006	17.789	BI5107002	29.303

To have the correct positioning of drill holes in combination with other counters or cabinets, you must use the following in the article number:

		Left panel	Right panel
No drill holes for connecting fittings	BI5107	0	0
Drill holes for standing height 1000 mm	BI5107	1	1
Drill holes for counter height 740 mm	BI5107	2	2
Drill holes for height adjustable counter	BI5107	3	3
Drill holes for recessed counter	BI5107	4	4

DISPLAY AND STORAGE

CONFIGURATION NO. 19

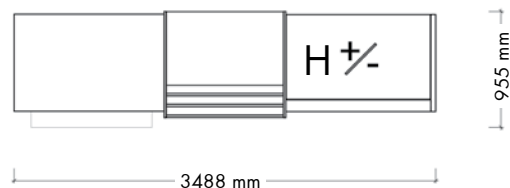

Rectangular height adjustable and rectangular counters with display cabinet

Components	Article no.	Price DKK	Quantity	DKK
Left side panel for height adjustable counter (H740 mm)	BI3804303	2.345,00	1	2.345
Height adjustable counter - starter, middle and end (W1200 mm)	BI24015006	29.248,00	1	29.248
Wooden front panel for height adjustable counter (W1200 x H740 mm)	BI350546	4.095,00	1	4.095
Display cabinet with shelves & pamphlet display (W1008 x H870 mm)	BI515115006	10.788,00	1	10.788
Rectangular counter - end (W1240 x H740 mm)	BI2003022003	5.995,00	1	5.995
Wooden front panel for rectangular counter (W1200 x H740 mm)	BI300546	2.368,00	1	2.368
Wooden bag shelf for rectangular counter (W1200 mm)	BI81053	1.535,00	1	1.535
Total price for configuration				56.374

Comments to configuration

- Monitor and text are not included in price.
- All prices are based on colours and surfaces in price group A, see pages 4-7 for colours.
- We recommend the use of desk grommets, cable rails and drawer pedestals with the Inform counter, see page 113.
- The bag shelf is in fact 1000 mm long, adapted to a 1200 mm front panel.

DISPLAY AND STORAGE

DISPLAY CABINETS WITH STORAGE

This is a cabinet with double function: Display at the front and cabinet at the back! Inserted shelves at the front provide perfect storage for loose pamphlets, as well as for books and DVD's. The cabinet offers practical additional surface when standing behind the counter and comes in different heights and widths. The cabinets are ready for direct integration with rectangular, curved and height adjustable counters. The open back of the cabinet can be equipped with lockable doors.

H870 mm - display cabinet with shelves at the back and pamphlet display in front

With bottom shelf and one middle shelf at the back. Doors can be installed on back of display cabinet, see page 100.

H x W x D mm	Item no. Melamine	Price DKK	Item no. Veneer	Price DKK
870 758 875	BI515715006	9.948	BI515715002	16.386
870 908 875	BI515915006	10.376	BI515915002	17.091
870 1008 875	BI515115006	10.788	BI515115002	17.769

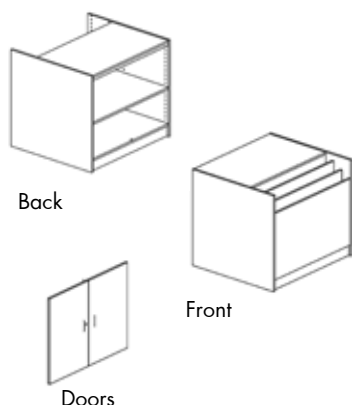

To have the correct positioning of drill holes in combination with other counters or cabinets, you must use the following in the article number:

		Left panel	Right panel
No drill holes for connecting fittings	BI515715	0	0
Drill holes for counter height 740 mm	BI515715	2	2
Drill holes for height adjustable counter	BI515715	3	3
Drill holes for recessed counter	BI515715	4	4

H1130 mm - display cabinet with shelves at the back and pamphlet display in front

With bottom shelf and two middle shelves at the back. Doors can be installed on back of display cabinet, see page 100.

H x W x D mm	Item no. Melamine	Price DKK	Item no. Veneer	Price DKK
1130 758 875	BI515727006	9.948	BI515727002	16.386
1130 908 875	BI515927006	12.858	BI515927002	21.179
1130 1008 875	BI515127006	13.341	BI515127002	21.976

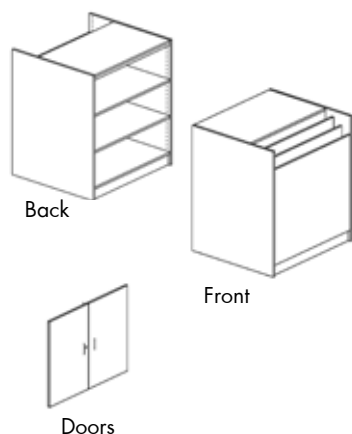

To have the correct positioning of drill holes in combination with other counters or cabinets, you must use the following in the article number:

		Left panel	Right panel
No drill holes for connecting fittings	BI515727	0	0
Drill holes for standing height 1000 mm	BI515727	1	1
Drill holes for counter height 740 mm	BI515727	2	2
Drill holes for height adjustable counter	BI515727	3	3
Drill holes for recessed counter	BI515727	4	4

DISPLAY AND STORAGE

CONFIGURATION NO. 20

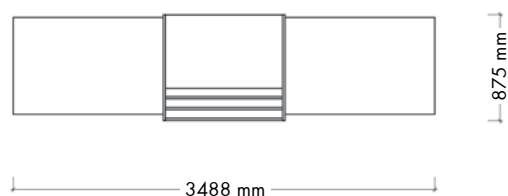

Rectangular counters with display cabinet with drawers

Components	Article no.	Price DKK	Quantity	DKK
Rectangular counter - starter (W1240 x H740 mm)	BI2001022003	5.995,00	1	5.995
Rectangular counter - end (W1240 x H740 mm)	BI2003022003	5.995,00	1	5.995
Wooden front panel for rectangular counter (W1200 x H740 mm)	BI300546	2.368,00	2	4.736
Display cabinet with drawers & pamphlet display (W865 x H870 mm)	BI520943006	21.493,00	1	21.493
Total price for configuration				38.219

Comments to configuration

- Monitor, drawer pedestal and keyboard are not included in price.
- All prices are based on colours and surfaces in price group A, see pages 4-7 for colours.
- We recommend the use of desk grommets, cable rails and drawer pedestals with the Inform counter, see page 113.

DISPLAY AND STORAGE

DISPLAY CABINETS WITH DRAWERS

This is a cabinet similar to the display cabinet with storage: It has the same front display, but with drawers at the back. Inserted shelves at the front provide perfect storage for loose pamphlets, as well as for books and DVD's. The drawers at the back are designed for organising different media by use of mobile dividers. The drawers are lockable and with drawer stop, which prevents the cabinet from tilting, when several drawers are open at the same time.

H895 mm - display cabinet with drawers at the back and pamphlet display in front

With 4 drawers. See page 100 for accessories for drawers.

H x W x D mm	Item no. Melamine	Price DKK	Item no. Veneer	Price DKK
895 865 894	BI520943006	21.493	BI520943002	35.402

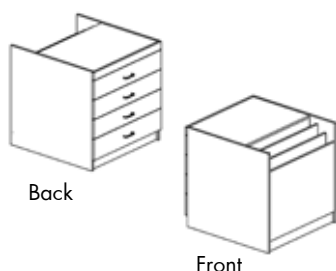

To have the correct positioning of drill holes in combination with other counters or cabinets, you must use the following in the article number:

	Item no.	Left panel	Right panel
No drill holes for connecting fittings	BI520943	0	0
Drill holes for counter height 740 mm	BI520943	2	2
Drill holes for height adjustable counter	BI520943	3	3
Drill holes for recessed counter	BI520943	4	4

H1130 mm - display cabinet with drawers at the back and pamphlet display in front

With 5 drawers. See page 100 for accessories for drawers.

H x W x D mm	Item no. Melamine	Price DKK	Item no. Veneer	Price DKK
1130 865 894	BI520957006	22.682	BI520957002	37.362

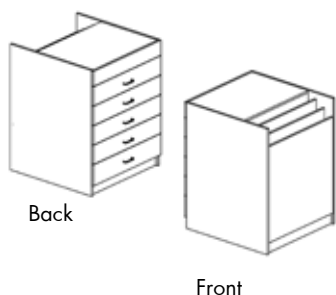

To have the correct positioning of drill holes in combination with other counters or cabinets, you must use the following in the article number:

	Item no.	Left panel	Right panel
No drill holes for connecting fittings	BI520957	0	0
Drill holes for standing height 1000 mm	BI520957	1	1
Drill holes for counter height 740 mm	BI520957	2	2
Drill holes for height adjustable counter	BI520957	3	3
Drill holes for recessed counter	BI520957	4	4

DISPLAY AND STORAGE

DISPLAY CABINETS WITH SHELVES AND SHELVING OPTIONS

Another cabinet with double function: Optional front display shelves and storage at the back! The front-side shelves (not included in price of cabinet) can be adjusted and can also be tilted for presenting your new acquisitions. With different heights and widths, the cabinets are ready for direct integration with rectangular, curved and height adjustable counters. The open back of the cabinet can be equipped with lockable doors.

H870 mm - display cabinet with shelves at the back and shelving options in the front

With bottom shelf and one middle shelf at the back. Front shelves are not included. Doors can be installed on back of display cabinet. See pages 100-101 for doors and shelves.

H x W x D mm	Item no. Melamine	Price DKK	Item no. Veneer	Price DKK
870 758 875	BI525715006	8.677	BI525715002	14.290
870 908 875	BI525915006	9.094	BI525915002	14.979
870 1008 875	BI525115006	9.700	BI525115002	15.976

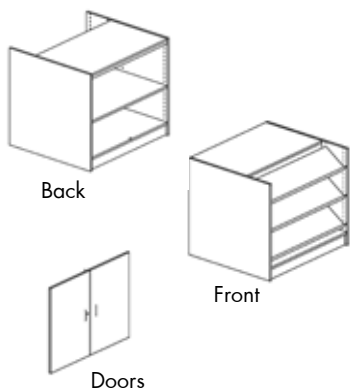

To have the correct positioning of drill holes in combination with other counters or cabinets, you must use the following in the article number:

		Left panel	Right panel
No drill holes for connecting fittings	BI5255715	0	0
Drill holes for counter height 740 mm	BI5255715	2	2
Drill holes for height adjustable counter	BI5255715	3	3
Drill holes for recessed counter	BI5255715	4	4

H1130 mm - display cabinet with shelves at the back and shelving options in the front

With bottom shelf and two middle shelves at the back. Front shelves are not included. Doors can be installed on back of display cabinet. See pages 100-101 for doors and shelves.

H x W x D mm	Item no. Melamine	Price DKK	Item no. Veneer	Price DKK
1130 758 875	BI525727006	9.671	BI525727002	15.929
1130 908 875	BI525927006	12.314	BI525927032	20.284
1130 1008 875	BI525127006	12.798	BI525127002	21.077

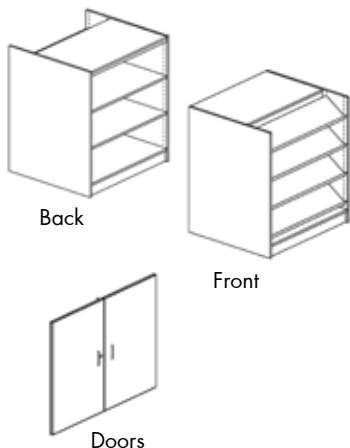

To have the correct positioning of drill holes in combination with other counters or cabinets, you must use the following in the article number:

		Left panel	Right panel
No drill holes for connecting fittings	BI525727	0	0
Drill holes for standing height 1000 mm	BI525727	1	1
Drill holes for counter height 740 mm	BI525727	2	2
Drill holes for height adjustable counter	BI525727	3	3
Drill holes for recessed counter	BI525727	4	4

DISPLAY AND STORAGE

DISPLAY CABINET WITH BOOK TROLLEY GARAGE

Use the space behind your counter - give your book trolley its own parking spot! You will not lose any space when you have the double function cabinet as part of your counter. At the same time, present your books or pamphlets at the front of the cabinet. The cabinets are ready for direct integration with rectangular, curved and height adjustable counters.

H1130 mm - display cabinet with book trolley garage at the back and shelving options in front

Inner dimension of garage: H1080 x W930 x D580 mm. Front shelves are not included, see page 101.

H x W x D mm	Item no. Melamine	Price DKK	Item no. Veneer	Price DKK
1130 1008 875	BI530197006	16.515	BI530197002	27.203

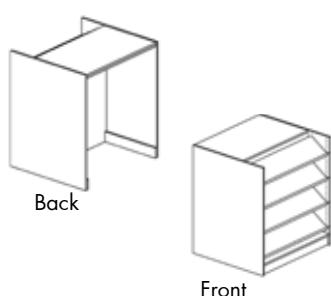

To have the correct positioning of drill holes in combination with other counters or cabinets, you must use the following in the article number:

	Item no.	Left panel	Right panel
No drill holes for connecting fittings	BI530187	0	0
Drill holes for standing height 1000 mm	BI530187	1	1
Drill holes for counter height 740 mm	BI530187	2	2
Drill holes for height adjustable counter	BI530187	3	3
Drill holes for recessed counter	BI530187	4	4

H1130 mm - display cabinet with book trolley garage at the back and pamphlet display in front

Inner dimension of garage: H1080 x W930 x D580 mm.

H x W x D mm	Item no. Melamine	Price DKK	Item no. Veneer	Price DKK
1130 1008 875	BI530187006	12.909	BI530187002	21.262

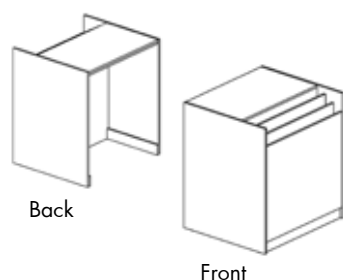

To have the correct positioning of drill holes in combination with other counters or cabinets, you must use the following in the article number:

	Item no.	Left panel	Right panel
No drill holes for connecting fittings	BI530197	0	0
Drill holes for standing height 1000 mm	BI530197	1	1
Drill holes for counter height 740 mm	BI530197	2	2
Drill holes for height adjustable counter	BI530197	3	3
Drill holes for recessed counter	BI530197	4	4

DISPLAY AND STORAGE

ACCESSORIES

Doors for display cabinet BI515 & BI525

With cylinder lock and door handles.



H x W mm	Item no. Melamine	Price DKK	Item no. Veneer	Price DKK
870 758	BI5407056	4.277	BI5407052	7.044
870 908	BI5409056	4.636	BI5409052	7.635
870 1008	BI5401056	4.997	BI5401052	8.231
1130 758	BI5407076	4.636	BI5407072	7.635
1130 908	BI5409076	4.997	BI5409072	8.231
1130 1008	BI5401076	5.360	BI5401072	8.827

Drawer organizer for display cabinet BI520

To organise media. Incl. silver coloured steel dividers, two stainless steel rods, mat and four mobile dividers. For approx. 200 CDs in standard cases, 1000 CDs in plastic cases or 90 DVDs.

Description

1 set for 1 drawer
1 additional divider

Item no.

Price
DKK

B4011859
B401186

1.613
137

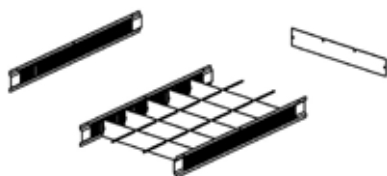

Bracket for sloping wooden and steel shelves

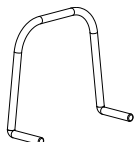

Item no.

Price
DKK

BN066

88

DISPLAY AND STORAGE

ACCESSORIES

Wooden shelf with steel backedge for display cabinet BI525 & BI530

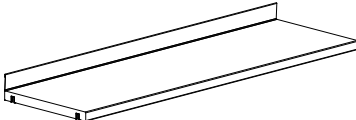
Snapfix incl. Steel backedge H47 mm. When turned, the shelf can be used as a sloping shelf by using the existing pins and bracket BN066.	W x D mm	Type of shelf	Item no. Melamine	Price DKK	Item no. Veneer	Price DKK
	500 250	Straight	B4018025216	577	B4018025212	950
	500 300	Sloping	B4018025316	638	B4018025312	1.050
	750 250	Straight	B4018027216	609	B4018027212	1.004
	750 300	Sloping	B4018027316	670	B4018027312	1.103
	900 250	Straight	B4018029216	617	B4018029212	1.016
	900 300	Sloping	B4018029316	713	B4018029312	1.174
	1000 250	Straight	B4018021216	834	B4018021212	1.373
	1000 300	Sloping	B4018021316	894	B4018021312	1.468

Wooden shelf for display cabinet BI525 & BI530

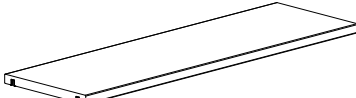
Snapfix incl.	W x D mm	Type of shelf	Item no. Melamine	Price DKK	Item no. Veneer	Price DKK
	500 250	Straight	B4018025206	488	B4018025202	803
	750 250	Straight	B4018027206	518	B4018027202	851
	900 250	Straight	B4018029206	532	B4018029202	875
	1000 250	Straight	B4018021206	738	B4018021202	1.216

Steel shelf with steel backedge for display cabinet BI525 & BI530

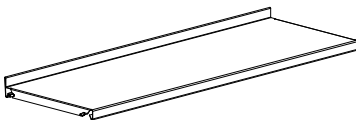
Pins incl. Steel backedge H25 mm. When turned, the shelf can be used as a sloping shelf by using the existing pins and bracket BN066.	W x D mm	Type of shelf	Item no.	Price DKK
	500 250	Straight	B401803521	412
	500 300	Sloping	B401803531	468
	750 250	Straight	B401803721	439
	750 300	Sloping	B401803731	478
	900 250	Straight	B401803921	442
	900 300	Sloping	B401803931	492
	1000 250	Straight	B401803121	448
	1000 300	Sloping	B401803131	499

Steel shelf for display cabinet BI525 & BI530

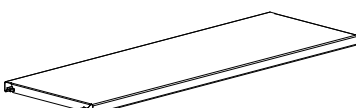
Pins incl.	W x D mm	Type of shelf	Item no.	Price DKK
	500 250	Straight	B401803520	347
	750 250	Straight	B401803720	365
	900 250	Straight	B401803920	375
	1000 250	Straight	B401803120	381

FUNCTIONS

CONFIGURATION NO. 21

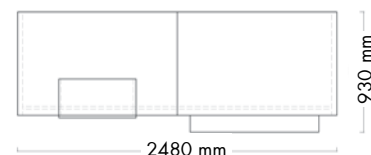

Rectangular counters (with counter top part & bag shelf)

Components	Article no.	Price DKK	Quantity	DKK
Rectangular counter - starter (W1240 x H740 mm)	BI2001022003	5.995,00	1	5.995
Rectangular counter - end (W1240 x H740 mm)	BI2003022003	5.995,00	1	5.995
Wooden front panel for rectangular counter (W1200 x H740 mm)	BI300546	2.368,00	2	4.736
Steel leg frame (H740 mm)	BI069146	2.855,00	1	2.855
Wooden counter top part with info sign (W600 x H490 mm)	BI820186	2.584,00	1	2.584
Wooden bag shelf for rectangular counter (W1200 mm)	BI81053	1.535,00	1	1.535
Total price for configuration				23.700

Comments to configuration

- Office chair and text are not included in price.
- All prices are based on colours and surfaces in price group A, see pages 4-7 for colours.
- We recommend the use of desk grommets, cable rails and drawer pedestals with the Inform counter, see page 113.
- The bag shelf is in fact 1000 mm long, adapted to a 1200 mm front panel.

FUNCTIONS

BAG SHELVES

Add functions to your counter. Below you will find products that can be built on to the Inform counter to make it more functional and user friendly. The wooden bag shelves below can only be used with wooden front panels, it is not possible to use with acrylic front panels. The distance from floor to top of shelf is 55 cm.

Wooden bag shelf for rectangular counter

Only use with wooden front panels. Do not use with acrylic front panels. Max. load 5 kg. Actual width of shelf is 200 mm shorter than the width of the counter.

Counter W x	Shelf W x	Shelf D
600	400	180
800	600	180
1000	800	180
1200	1000	180
1400	1200	180
1600	1400	180

Item no.
HPL

Price
DKK

BI81013	1.264
BI81033	1.355
BI81043	1.443
BI81053	1.535
BI81063	1.625
BI81073	1.714



Wooden bag shelf for 45° curved counter

Only use with wooden front panels. Do not use with acrylic front panels. Max. load 5 kg.

W x	D
1710	180

Item no.
HPL

Price
DKK

BI815453	4.063
----------	-------

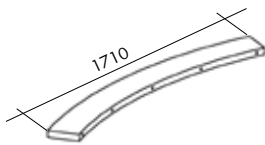

Wooden bag shelf for 90° curved counter

Only use with wooden front panels. Do not use with acrylic front panels. Max. load 5 kg.

W x	D
1875	180

Item no.
HPL

Price
DKK

BI815903	4.242
----------	-------

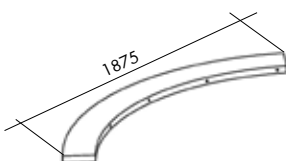

FUNCTIONS

CONFIGURATION NO. 22

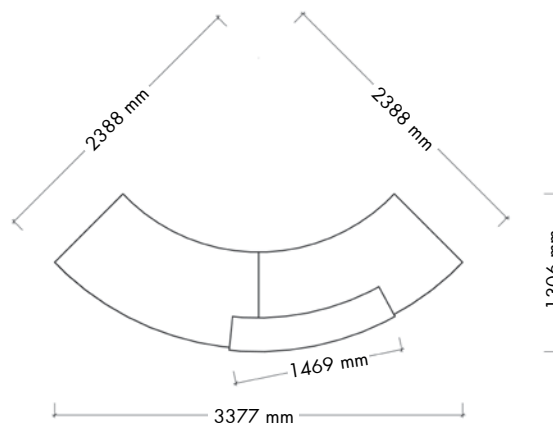

45° curved counters (with counter top part)

Components	Article no.	Price DKK	Quantity	DKK
45° curved counter - starter (H740 mm)	BI2051428003	9.243,00	1	9.243
45° curved counter - end (H740 mm)	BI2053428003	9.243,00	1	9.243
Wooden front panel for 45° curved counter (H740 mm)	BI3204543	15.820,00	2	31.640
Steel leg frame (H740 mm)	BI069146	2.855,00	1	2.855
Wooden counter top part with info sign (1400 x H490 mm)	BI82545683	11.240,00	1	11.240
Total price for configuration				64.221

Comments to configuration

- Computer, office chair and text are not included in price.
- All prices are based on colours and surfaces in price group A, see pages 4-7 for colours.
- We recommend the use of desk grommets, cable rails and drawer pedestals with the Inform counter, see page 113.

FUNCTIONS

CONFIGURATION NO. 23

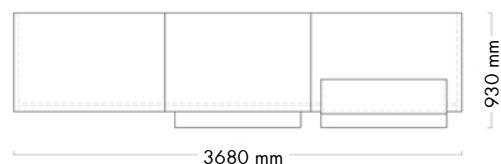

Rectangular counters (with acrylic front panel, bag shelf & counter top part with bag shelf)

Components	Article no.	Price DKK	Quantity	DKK
Rectangular counter - starter (W1240 x H740 mm)	BI2001022003	5.995,00	1	5.995
Rectangular counter - middle (W1200 x H740 mm)	BI2002082003	3.740,00	1	3.740
Wooden front panel for rectangular counter (W1200 x H740 mm)	BI300546	2.368,00	2	4.736
Rectangular counter - end (W1240 x H740 mm)	BI2003022003	5.995,00	1	5.995
Acrylic front panel for rectangular counter (W1200 x H740 mm)	BI310546	7.016,00	1	7.016
Steel leg frame (H740 mm)	BI069146	2.855,00	2	5.710
Wooden counter top part with bag shelf (W1000 x H490 mm)	BI830486	4.246,00	1	4.246
Wooden bag shelf (W1200 mm)	BI81053	1.535,00	1	1.535
Stainless steel desk grommet	B4015553	517,00	1	517
Total price for configuration				39.490

Comments to configuration

- Monitor, key board, office chair and text are not included in price.
- All prices are based on colours and surfaces in price group A, see pages 4-7 for colours.
- We recommend the use of desk grommets, cable rails and drawer pedestals with the Inform counter, see page 113.
- The counter top part and bag shelf are in fact 1000 mm long, adapted to a 1200 mm front panel.

FUNCTIONS

COUNTER TOP PARTS WITH INFO SIGN

Add functions to your counter. Below you will find products that can be built on to the Inform counter to make it more functional and user friendly.

Wooden counter top part with info sign for rectangular counter

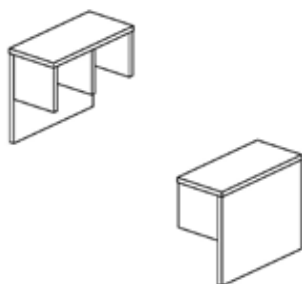

W x H x D mm (OD)	H x D mm (ID)	Item no. Melamine	Price DKK
600 490 280	235 250	BI820186	2.584
800 490 280	235 250	BI820386	2.764
1000 490 280	235 250	BI820486	3.576
1200 490 280	235 250	BI820586	3.934
1400 490 280	235 250	BI820686	4.297
1600 490 280	235 250	BI820786	4.660
600 580 280	325 250	BI820196	2.584
800 580 280	325 250	BI820396	2.764
1000 580 280	325 250	BI820496	3.576
1200 580 280	325 250	BI820596	3.934
1400 580 280	325 250	BI820696	4.297
1600 580 280	325 250	BI820796	4.660

Wooden counter top part with info sign for 45° curved counter

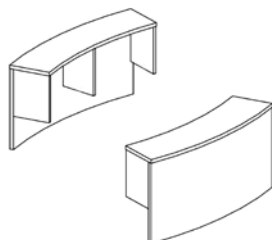

W x H x D mm (OD)	H x D mm (ID)	Item no. HPL	Price DKK
800 490 280	235 250	BI82545383	7.276
1000 490 280	235 250	BI82545483	9.474
1200 490 280	235 250	BI82545583	10.636
1400 490 280	235 250	BI82545683	11.240
800 580 280	325 250	BI82545393	8.503
1000 580 280	325 250	BI82545493	10.239
1200 580 280	325 250	BI82545593	11.343
1400 580 280	325 250	BI82545693	12.110

Wooden counter top part with info sign for 90° curved counter

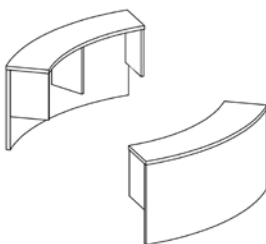

W x H x D mm (OD)	H x D mm (ID)	Item no. HPL	Price DKK
800 490 280	235 250	BI82590383	7.709
1000 490 280	235 250	BI82590483	9.980
1200 490 280	235 250	BI82590583	11.041
1400 490 280	235 250	BI82590683	11.636
800 580 280	325 250	BI82590393	8.927
1000 580 280	325 250	BI82590493	10.662
1200 580 280	325 250	BI82590593	11.762
1400 580 280	325 250	BI82590693	12.536

FUNCTIONS

COUNTER TOP PARTS WITH INFO SIGN

Add functions to your counter. Below you will find products that can be built on to the Inform counter to make it more functional and user friendly.

Wooden counter top part with info sign for rectangular counter

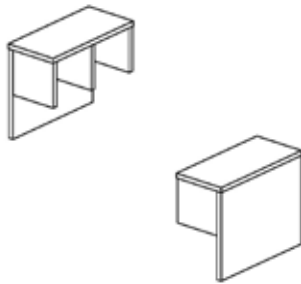

W x H x D mm (OD)	H x D mm (ID)	Item no. Veneer	Price DKK
600 490 280	235 250	BI820182	4.256
800 490 280	235 250	BI820382	4.554
1000 490 280	235 250	BI820482	5.891
1200 490 280	235 250	BI820582	6.480
1400 490 280	235 250	BI820682	7.078
1600 490 280	235 250	BI820782	7.676
600 580 280	325 250	BI820192	4.256
800 580 280	325 250	BI820392	4.554
1000 580 280	325 250	BI820492	5.891
1200 580 280	325 250	BI820592	6.480
1400 580 280	325 250	BI820692	7.078
1600 580 280	325 250	BI820792	7.676

Wooden counter top part with info sign for 45° curved counter

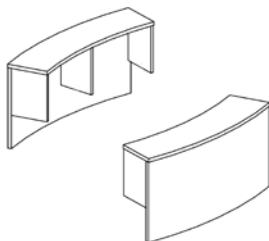

W x H x D mm (OD)	H x D mm (ID)	Item no. Veneer	Price DKK
800 490 280	235 250	BI82545382	8.325
1000 490 280	235 250	BI82545482	10.838
1200 490 280	235 250	BI82545582	12.169
1400 490 280	235 250	BI82545682	12.861
800 580 280	325 250	BI82545392	9.728
1000 580 280	325 250	BI82545492	11.714
1200 580 280	325 250	BI82545592	12.978
1400 580 280	325 250	BI82545692	13.856

Wooden counter top part with info sign for 90° curved counter

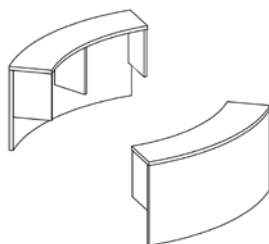

W x H x D mm (OD)	H x D mm (ID)	Item no. Veneer	Price DKK
800 490 280	235 250	BI82590382	8.819
1000 490 280	235 250	BI82590482	11.419
1200 490 280	235 250	BI82590582	12.631
1400 490 280	235 250	BI82590682	13.314
800 580 280	325 250	BI82590392	10.212
1000 580 280	325 250	BI82590492	12.198
1200 580 280	325 250	BI82590592	13.455
1400 580 280	325 250	BI82590692	14.342

FUNCTIONS

COUNTER TOP PARTS WITH BAG SHELF

Add functions to your counter. Below you will find products that can be built on to the Inform counter to make it more functional and user friendly. The counter top parts can only be used with wooden front panels, it is not possible to use with acrylic front panels.

Wooden counter top part with bag shelf for rectangular counter

Max. load 5 kg.

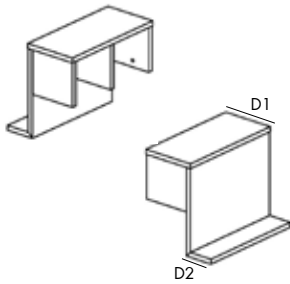

W x H x D1 x D2 mm (OD)	H x D mm (ID)	Item no. Melamine	Price DKK
600 490 280 130	235 250	BI830186	3.886
800 490 280 130	235 250	BI830386	4.039
1000 490 280 130	235 250	BI830486	4.246
1200 490 280 130	235 250	BI830586	4.500
1400 490 280 130	235 250	BI830686	4.789
1600 490 280 130	235 250	BI830786	5.505
600 580 280 130	325 250	BI830196	3.886
800 580 280 130	325 250	BI830396	4.039
1000 580 280 130	325 250	BI830496	4.246
1200 580 280 130	325 250	BI830596	4.500
1400 580 280 130	325 250	BI830696	4.789
1600 580 280 130	325 250	BI830796	5.505

Wooden counter top part with bag shelf for 45° curved counter

Max. load 5 kg.

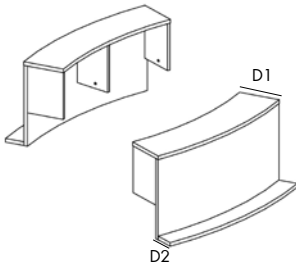

W x H x D1 x D2 mm (OD)	H x D mm (ID)	Item no. HPL	Price DKK
800 490 280 130	235 250	BI83545383	11.732
1000 490 280 130	235 250	BI83545483	12.028
1200 490 280 130	235 250	BI83545583	12.322
1400 490 280 130	235 250	BI83545683	13.225
800 580 280 130	325 250	BI83545393	12.529
1000 580 280 130	325 250	BI83545493	12.827
1200 580 280 130	325 250	BI83545593	13.127
1400 580 280 130	325 250	BI83545693	13.759

Wooden counter top part with bag shelf for 90° curved counter

Max. load 5 kg.

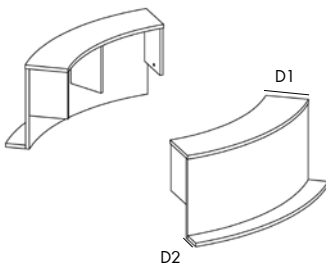

W x H x D1 x D2 mm (OD)	H x D mm (ID)	Item no. HPL	Price DKK
800 490 280 130	235 250	BI83590383	12.958
1000 490 280 130	235 250	BI83590483	13.255
1200 490 280 130	235 250	BI83590583	13.552
1400 490 280 130	235 250	BI83590683	13.850
800 580 280 130	325 250	BI83590493	13.678
1000 580 280 130	325 250	BI83590593	13.976
1200 580 280 130	325 250	BI83590693	14.299
1400 580 280 130	325 250	BI83590393	13.381

FUNCTIONS

COUNTER TOP PARTS WITH BAG SHELF

Add functions to your counter. Below you will find products that can be built on to the Inform counter to make it more functional and user friendly. The counter top parts can only be used with wooden front panels, it is not possible to use with acrylic front panels.

Wooden counter top part with bag shelf for rectangular counter

Max. load 5 kg.

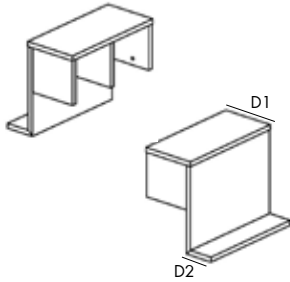

W x H x D1 x D2 mm (OD)	H x D mm (ID)	Item no. Veneer	Price DKK
600 490 280 130	235 250	BI830182	6.397
800 490 280 130	235 250	BI830382	6.653
1000 490 280 130	235 250	BI830482	6.991
1200 490 280 130	235 250	BI830582	7.413
1400 490 280 130	235 250	BI830682	7.887
1600 490 280 130	235 250	BI830782	9.069
600 580 280 130	325 250	BI830192	6.397
800 580 280 130	325 250	BI830392	6.653
1000 580 280 130	325 250	BI830492	6.991
1200 580 280 130	325 250	BI830592	7.413
1400 580 280 130	325 250	BI830692	7.887
1600 580 280 130	325 250	BI830792	9.069

Wooden counter top part with bag shelf for 45° curved counter

Max. load 5 kg.

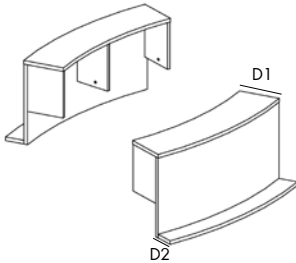

W x H x D1 x D2 mm (OD)	H x D mm (ID)	Item no. Veneer	Price DKK
800 490 280 130	235 250	BI83545382	13.420
1000 490 280 130	235 250	BI83545482	13.762
1200 490 280 130	235 250	BI83545582	14.096
1400 490 280 130	235 250	BI83545682	15.076
800 580 280 130	325 250	BI83545392	14.334
1000 580 280 130	325 250	BI83545492	14.673
1200 580 280 130	325 250	BI83545592	14.924
1400 580 280 130	325 250	BI83545692	15.685

Wooden counter top part with bag shelf for 90° curved counter

Max. load 5 kg.

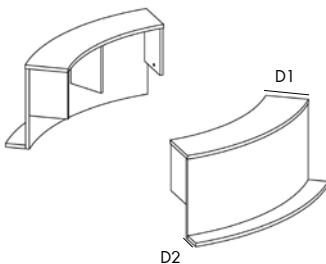

W x H x D1 x D2 mm (OD)	H x D mm (ID)	Item no. Veneer	Price DKK
800 490 280 130	235 250	BI83590382	14.826
1000 490 280 130	235 250	BI83590482	15.165
1200 490 280 130	235 250	BI83590582	15.504
1400 490 280 130	235 250	BI83590682	15.845
800 580 280 130	325 250	BI83590392	15.309
1000 580 280 130	325 250	BI83590492	15.649
1200 580 280 130	325 250	BI83590592	15.989
1400 580 280 130	325 250	BI83590692	16.359

FUNCTIONS

CONFIGURATION NO. 24

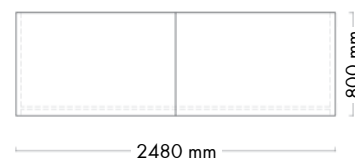

Rectangular counters (with decorative boards)

Components	Article no.	Price DKK	Quantity	DKK
Rectangular counter - starter (W1240 x H740 mm)	BI2001022003	5.995,00	1	5.995
Rectangular counter - end (W1240 x H740 mm)	BI2003022003	5.995,00	1	5.995
Wooden front panel for rectangular counter (W1200 x H740 mm)	BI300546	2.368,00	2	4.736
Steel leg frame (H740 mm)	BI069146	2.855,00	1	2.855
Wooden decorative board - high (W600 x H740 mm)	BI840146	540,00	1	540
Wooden decorative board - narrow (W600 x H190 mm)	BI845116	339,00	1	339
Total price for configuration				20.460

Comments to configuration

- Office chair and text are not included in price.
- All prices are based on colours and surfaces in price group A, see pages 4-7 for colours.
- We recommend the use of desk grommets, cable rails and drawer pedestals with the Inform counter, see page 113.

FUNCTIONS

DECORATIVE BOARDS AND INFO SIGNS

Wooden decorative board - high

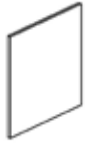

W	x	H	x	D	Item no. Melamine	Price DKK	Item no. Veneer	Price DKK
				mm				
600	740	19			BI840146	540	BI840142	888
600	1000	19			BI840166	634	BI840162	1.043

Wooden decorative board - narrow

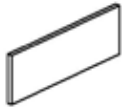

W	x	H	x	D	Item no. Melamine	Price DKK	Item no. Veneer	Price DKK
				mm				
600	190	19			BI845116	339	BI845112	560
800	190	19			BI845316	369	BI845312	608
1000	190	19			BI845416	397	BI845412	653
1200	190	19			BI845516	420	BI845512	692
1400	190	19			BI845616	459	BI845612	756
1600	190	19			BI845716	487	BI845712	803

Wooden info sign

Melamine/veneer board. Only use with wooden front panels. Do not use with acrylic front panels.

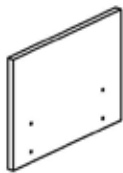

W	x	H	x	D	Item no. Melamine	Price DKK	Item no. Veneer	Price DKK
				mm				
600	430	25			BI850126	1.284	BI850122	2.115
800	430	25			BI850326	1.427	BI850322	2.348
1000	430	25			BI850426	1.650	BI850422	2.720
1200	430	25			BI850526	1.789	BI850522	2.943

Acrylic info sign (se configuration no 25.)

Acrylic frosted white glazed board. Only use with wooden front panels. Do not use with acrylic front panels.

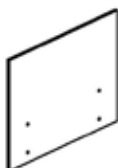

W	x	H	x	D	Item no. Acrylic	Price DKK
				mm		
600	430	10			BI85512	2.533
800	430	10			BI85532	2.619
1000	430	10			BI85542	2.746
1200	430	10			BI85552	2.919

FUNCTIONS

CONFIGURATION NO. 25

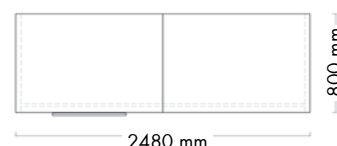

Rectangular counters (with acrylic info sign, desk grommet and monitor arm)

Components	Article no.	Price DKK	Quantity	DKK
Rectangular counter - starter (W1240 x H740 mm)	BI2001022003	5.995,00	1	5.995
Rectangular counter - end (W1240 x H740 mm)	BI2003022003	5.995,00	1	5.995
Wooden front panel for rectangular counter (W1200 x H740 mm)	BI300546	2.368,00	1	2.368
Acrylic front panel for rectangular counter (W1200 x H740 mm)	BI310546	7.016,00	1	7.016
Steel leg frame (H740 mm)	BI069146	2.855,00	1	2.855
Info sign - acrylic frosted white glazed (W600 x H430 mm)	BI85512	2.533,00	1	2.533
Monitor arm	B401184	6.354,00	1	6.354
Total price for configuration				33.116

Comments to configuration

- Monitor, office chair and text are not included in price.
- All prices are based on colours and surfaces in price group A, see pages 4-7 for colours.
- We recommend the use of desk grommets, cable rails and drawer pedestals with the Inform counter, see page 113.
- It is necessary to drill an Ø80 mm hole for the monitor arm on site or modify the article number for counter for predrilled hole, see pages 120-121.

FUNCTIONS

FUNCTIONAL ACCESSORIES

Desk grommet

Ø80 mm. Drill hole is not included. For placement of drill hole, see cable conduct on pages 122-123.



Material	Colour	Item no.	Price DKK
Plastic	Oyster white	B4015548	158
Plastic	Black	B4015542	158
Plastic	Silver	B4015549	158
Metal	Stainless steel	B4015553	517

Monitor arm

Silver. For placement of drill hole, see cable conduct on pages 120-121. Drill holes for monitor arm will most often be drilled on site.



Item no.	Price DKK
B401184	6.354

CPU holder

W230 x H551 x D500 mm. Laquered steel. Practical storage of CPU holder under counter. Does not fit with recessed counter.

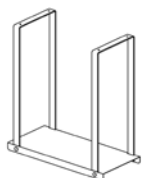

Item no.	Price DKK
B401180	1.606

Cable channel

W495 x H70 x D115 mm. Laquered steel. Is bendable - can be used with both straight and curved counters. For required quantities, see below.

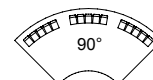
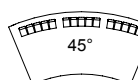
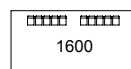
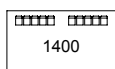
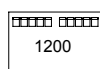

Item no.	Price DKK
B401182A28	371

Drawer pedestal

W442 x H615 x D585 mm. With office supplies drawer and 2/3 drawers.

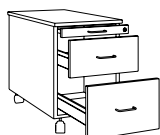

Drawers	Item no. Melamine	Price DKK	Item no. Veneer	Price DKK
1 drawer (128 mm) 1 drawer (320 mm)	B401195256	12.578	B401195252	20.717
1 drawer (192 mm) 1 drawer (256 mm)	B401195346	11.690	B401195342	19.255
2 drawers (128 mm) 1 drawer (192 mm)	B401195236	13.794	B401195232	22.724

FUNCTIONS

POWER SOCKETS

Power socket Square 80

W181 x D96 mm with lid open.
With sliding lid.
Mounting hole Ø80 mm.
Worktop thickness 10-50 mm.
3 m cable length.

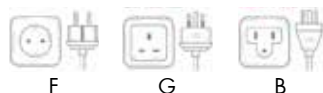

Colour	USB	Type	Market	Item no.	Price DKK
Black	1	1 x F	BE/DE/DK/FR/SE	B4015002101	1.815
White	1	1 x F	BE/DE/DK/FR/SE	B4015001101	1.815
Black	1	1 x G	GB	B4015002311	1.815
White	1	1 x G	GB	B4015001311	1.815
Black	1	1 x B	US	B4015002221	1.815

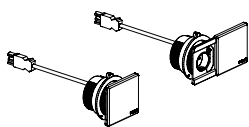

Built-in power socket BackFlip

W225 x D105 mm.
Lid flips 180 deg.
Mounting depth 53 mm.
Worktop thickness 10-40 mm.
2,5 m cable length.



Colour	USB	Type	Market	Item no.	Price DKK
Stainless steel	2	2 x F	BE/DE/DK/FR/SE	B4015013102	3.252
Stainless steel	2	2 x G	GB	B4015013312	3.252

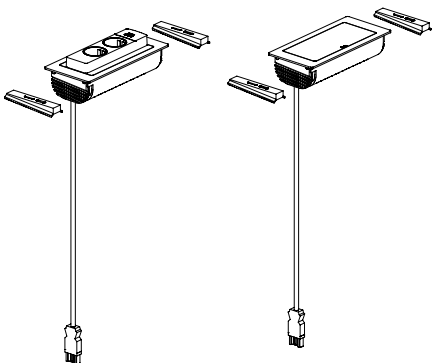

FUNCTIONS

POWER SOCKETS

Built-in power socket FlipTop Push

W260 x D167 mm.
Open lid with soft touch.
Mounting depth 68 mm.
Worktop thickness 10-50 mm.
3 m cable length.

Colour	USB	Type	Market	Item no.	Price DKK
Stainless steel	2	3 x F	BE/DE/DK/FR/SE	B4015023103	5.210
Stainless steel	2	2 x G	GB	B4015023312	5.210

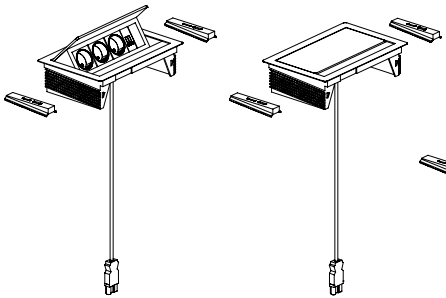

Built-in power socket FrameDock

W260 x D167 mm.
Mounting depth 51 mm.
Worktop thickness 5-38 mm.
3 m cable length.

Colour	USB	Type	Market	Item no.	Price DKK
Black	2	3 x F	BE/DE/DK/FR/SE	B4015032103	3.242
White	2	3 x F	BE/DE/DK/FR/SE	B4015031103	3.242
Black	2	2 x G	GB	B4015032312	3.242
Black	2	2 x B	US	B4015032222	3.242



FRONT PANEL OPTIONS

CONFIGURATION NO. 26

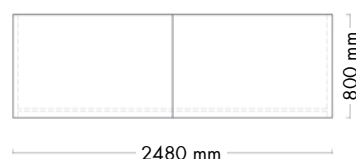

Rectangular counters (with acrylic front panels and lighting)

Components	Article no.	Price DKK	Quantity	DKK
Rectangular counter - starter (W1240 x H740 mm)	BI2001022003	5.995,00	1	5.995
Rectangular counter - end (W1240 x H740 mm)	BI2003022003	5.995,00	1	5.995
Acrylic front panel for rectangular counter (W1200 x H740 mm)	BI310546	7.016,00	2	14.032
Light for acrylic front panel (W1200 mm)	BI86051	2.224,00	2	4.448
Steel leg frame (H740 mm)	BI069146	2.855,00	1	2.855
Monitor arm	B401184	6.354,00	1	6.354
Total price for configuration				39.679

Comments to configuration

- Monitor and office chair are not included in price.
- All prices are based on colours and surfaces in price group A, see pages 4-7 for colours.
- We recommend the use of desk grommets, cable rails and drawer pedestals with the Inform counter, see page 113.
- It is necessary to drill an Ø80 mm hole for the monitor arm on site or modify the article number for counter for predrilled hole, see pages 120-121.
- Above article number for light is for German voltage and plug. Contact Sales for further information on voltage and plug for other countries.

FRONT PANEL OPTIONS

LED LIGHT

Create your own individual counter! You can differentiate your counter by use of acrylic front panels with light. See Design Options for acrylic front panel options. Note - the LED lighting can only be used for Standard Inform rectangular and curved counters.

Light for rectangular counter with acrylic front panel

Light mounted underneath table top on the inside of the counter. With cable and plug for the European market (except UK). Contact sales for plug and voltage for other countries.	W counter	W lamp	Watt	Item no.	Price DKK
	800	595	1 x 14W	BI86031	2.049
	1000	895	1 x 21W	BI86041	2.224
	1200	895	1 x 21W	BI86051	2.224
	1400	1195	1 x 28W	BI86061	2.582
	1600	1495	1 x 35W	BI86071	2.715

Light for 45° and 90° curved counter with acrylic front panel

Light mounted underneath table top on the inside of the counter. With cable and plug for the European market (except UK). Contact sales for plug and voltage for other countries.	Deg.	W lamp	Watt	Item no.	Price DKK
	45°	595	2 x 14W	BI862451	4.034
	90°	595	2 x 14W	BI862901	4.034

FRONT PANEL OPTIONS

CONFIGURATON NO. 27

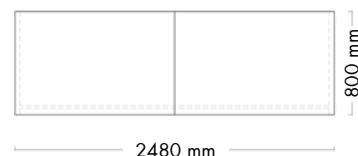

Rectangular counters (with graphics on wooden front panel)

Components	Article no.	Price DKK	Quantity	DKK
Rectangular counter - starter (W1240 x H740 mm)	BI2001022003	5.995,00	1	5.995
Rectangular counter - end (W1240 x H740 mm)	BI2003022003	5.995,00	1	5.995
Wooden front panel for rectangular counter (W1200 x H740 mm)	BI300546	2.368,00	2	4.736
Additional graphics to wooden front panel (W1200 x H740 mm)	BI86454	2.809,00	2	5.618
Steel leg frame (H740 mm)	BI069146	2.855,00	1	2.855
Monitor arm	B401184	6.354,00	1	6.354
Total price for configuration				31.553

Comments to configuration

- Monitor, key board and office chair are not included in price.
- All prices are based on colours and surfaces in price group A, see pages 4-7 for colours.
- We recommend the use of desk grommets, cable rails and drawer pedestals with the Inform counter, see page 113.
- It is necessary to drill an Ø80 mm hole for the monitor arm on site or modify the article number for counter for predrilled hole, see pages 120-121.

FRONT PANEL OPTIONS

GRAPHICS

Create your own individual counter! Use the front of the counter as a display for your ideas. The Inform counter gives you the opportunity to design all wooden front panels in accordance with your wishes and requirements. Use pictures, graphics or text to make a statement!

Front image for rectangular front panel

Price for full size sticker. Smaller stickers and logos on request. Price excl. front panel.	H mm	W mm	Item no.	Price DKK
	740	600	BI86414	2.105
	740	800	BI86434	2.279
	740	1000	BI86444	2.457
	740	1200	BI86454	2.809
	740	1400	BI86464	2.984
	740	1600	BI86474	3.276
	1000	600	BI86416	2.457
	1000	800	BI86436	2.633
	1000	1000	BI86446	2.809
	1000	1200	BI86456	3.158
	1000	1400	BI86466	3.334
	1000	1600	BI86476	3.663

Front image for 45° curved front panel

Price for full size sticker. Smaller stickers and logos on request. Price excl. front panel.	H mm	W mm	Item no.	Price DKK
	740	1830	BI866454	3.158
	1000	1850	BI866456	3.509

Front image for 90° curved front panel

Price for full size sticker. Smaller stickers and logos on request. Price excl. front panel.	H mm	W mm	Item no.	Price DKK
	740	1830	BI866904	3.158
	1000	1850	BI866906	3.509

Front image for corner front panel

Price for full size sticker. Smaller stickers and logos on request. Price excl. front panel.	H mm	W mm	Item no.	Price DKK
	740	800	BI8684	5.618
	1000	800	BI8686	6.314

Text for front panel

Item no.	Price DKK
B400003	

DRILL HOLES

FOR CABLE CONDUCT

It is possible to have counters delivered with predrilled holes and desk grommets for cable conduct. There is a surcharge per drill hole and desk grommet. Please inform Customer Service where you would like the predrilled hole to be placed (0-7) and which desk grommet (0/2/3/8/9) you would like. Remember to view the counter from left to right, as if sitting behind the counter.

Drill hole for desk grommet for rectangular, step and height adjustable counters

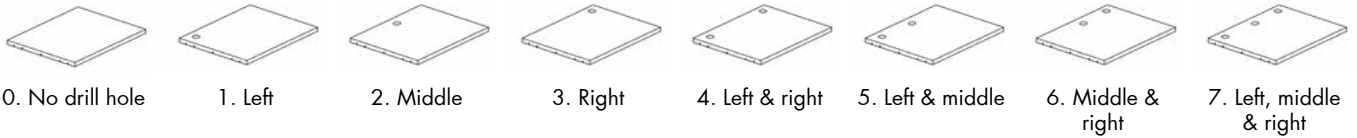

Drill hole for desk grommet for recessed rectangular counters

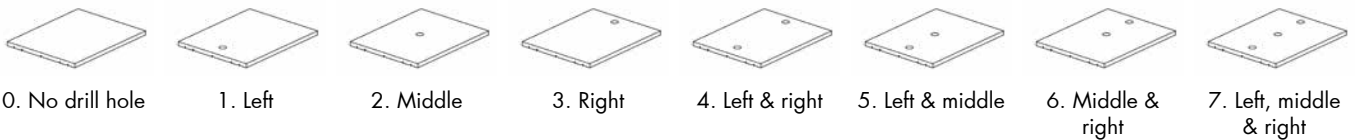

Drill hole for desk grommet for 45° and 90° curved counters

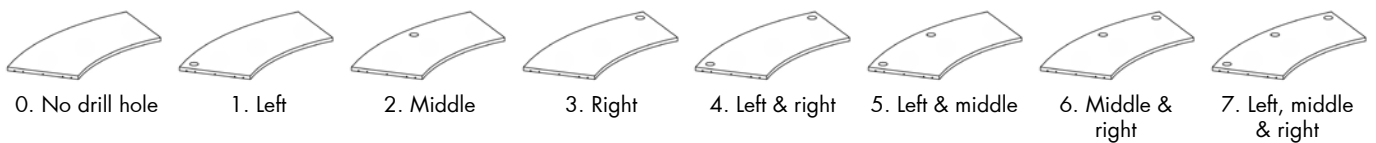

Drill hole for desk grommet for 45° and 90° recessed curved counters

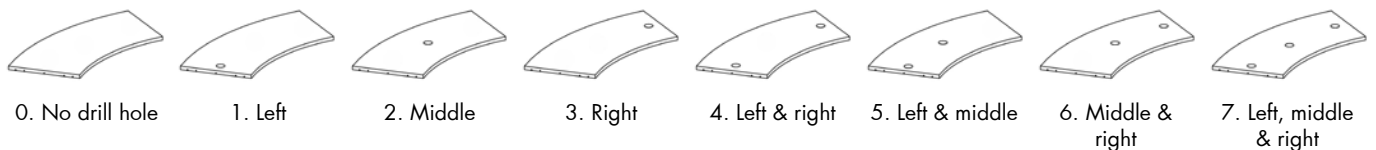

DRILL HOLES

FOR CABLE CONDUCT

It is possible to have counters delivered with predrilled holes and desk grommets for cable conduct. There is a surcharge per drill hole and desk grommet. Please inform Customer Service where you would like the predrilled hole to be placed (0-7) and which desk grommet (0/2/3/8/9) you would like. Remember to view the counter from left to right, as if sitting behind the counter.

Drill hole for desk grommet for corner counter - side A

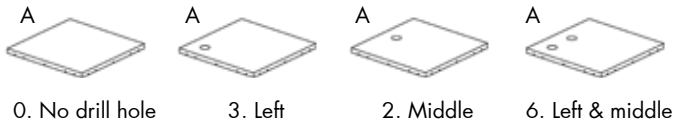

0. No drill hole 1. Left 2. Middle 3. Left & middle

Drill hole for desk grommet for corner counter - side B

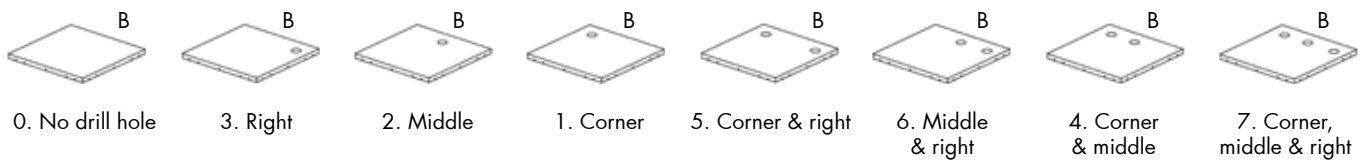

0. No drill hole 1. Corner 2. Middle 3. Right 4. Corner & middle 5. Corner & right 6. Middle & right 7. Corner, middle & right

Drill hole for desk grommet for triangular corner counter

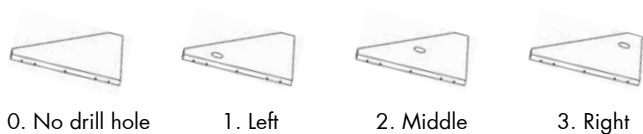

0. No drill hole 1. Left 2. Middle 3. Right

Desk grommet

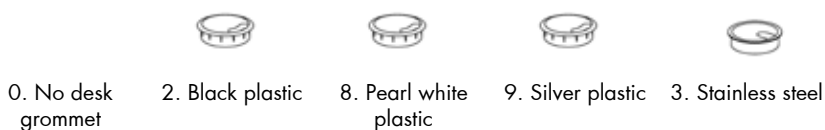

0. No desk grommet 1. Black plastic 2. Pearl white plastic 3. Silver plastic 4. Stainless steel

RFID INSTALLATION

PREPARATION FOR INSTALLATION OF RFID IN COUNTERTOP

The Inform counter offers the option to install an RFID PCB under the countertop, whether straight, curved or height adjustable. The 40 mm thick countertop is recessed below the central section to allow for the optimal positioning of the RFID PCB as needed. As far as the dimension of the countertop is concerned, the central recessed section leaves a peripheral circumference of 80 mm to 110 mm to preserve the visual aesthetics of the 40 mm top. In the recessed section, the countertop is 20 mm thick, thus complying with the technical specifications of most RFID systems for counters.

RFID installation in rectangular counter

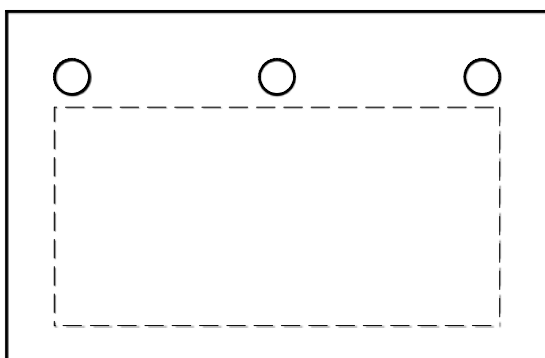

RFID installation in recessed rectangular counter

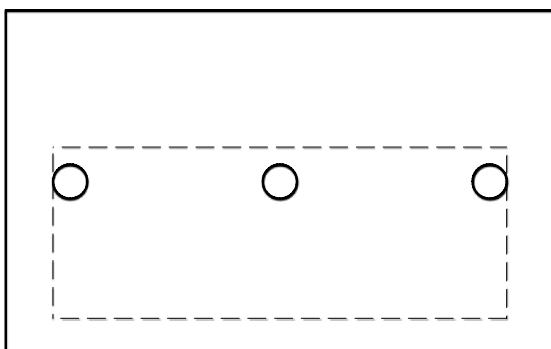

RFID INSTALLATION

PREPARATION FOR INSTALLATION OF RFID IN COUNTERTOP

The Inform counter offers the option to install an RFID PCB under the countertop, whether straight, curved or height adjustable. The 40 mm thick countertop is recessed below the central section to allow for the optimal positioning of the RFID PCB as needed. As far as the dimension of the countertop is concerned, the central recessed section leaves a peripheral circumference of 80 mm to 110 mm to preserve the visual aesthetics of the 40 mm top. In the recessed section, the countertop is 20 mm thick, thus complying with the technical specifications of most RFID systems for counters.

RFID installation in 45° curved counters

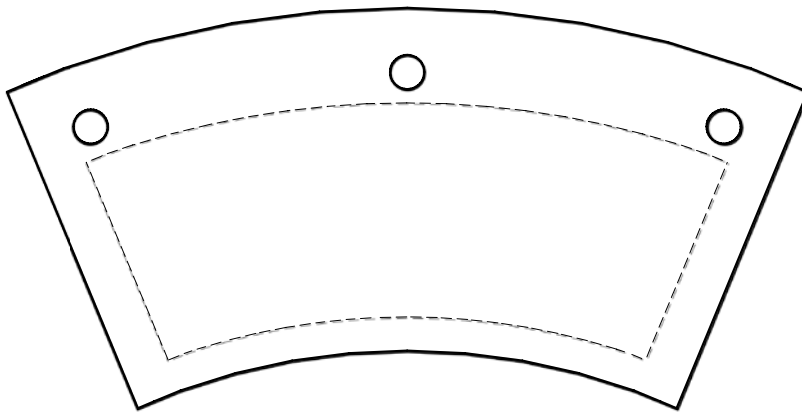

RFID installation in 90° curved counters

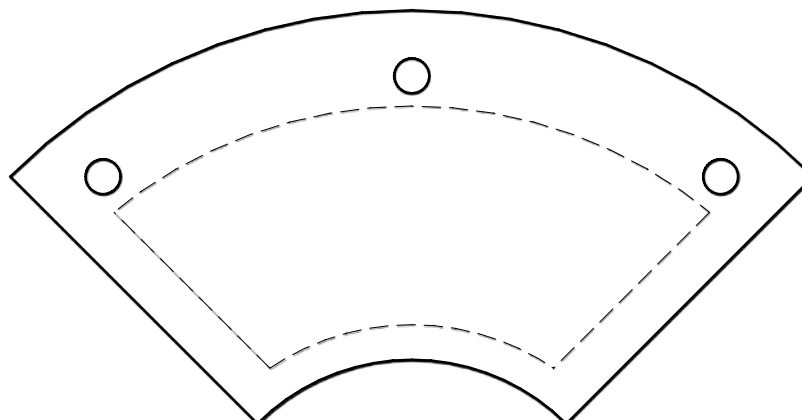



DANMARK

Lammhults Biblioteksdesign A/S
Dalbækvej 1
6670 Holsted

bci@bci.dk
www.bci.dk

SVERIGE

Lammhults Biblioteksdesign AB
Odlarevägen 16
226 60 Lund

eurobib@eurobib.se
www.eurobib.se

STORBRITANNIEN

thedesignconcept Ltd.
The Old Bakery,
10 Greenless Road
Cambuslang Belgrave Street
Glasgow G72 8JJ

info@thedesignconcept.co.uk
www.thedesignconcept.co.uk

FRANKRIG

BC Intérieur Sarl
6 allée Kepler
77420 Champs sur Marne

bci@bcinterieur.com
www.bcinterieur.com

TYSKLAND

Schulz Speyer Bibliothekstechnik AG
Hafenstraße 2
67346 Speyer

sales@schulzspeyer.de
www.schulzspeyer.de

NORGE

BS Eurobib AS
Alf Bjerckes Vei 20
0582 Oslo

post@bseurobib.no
www.bseurobib.no

BELGIEN

SBNL - Schulz Benelux BVBA
Appelweg 94 C
3221 Holsbeek

info@sbnl.be
www.sbnl.be