

Assembly Guide

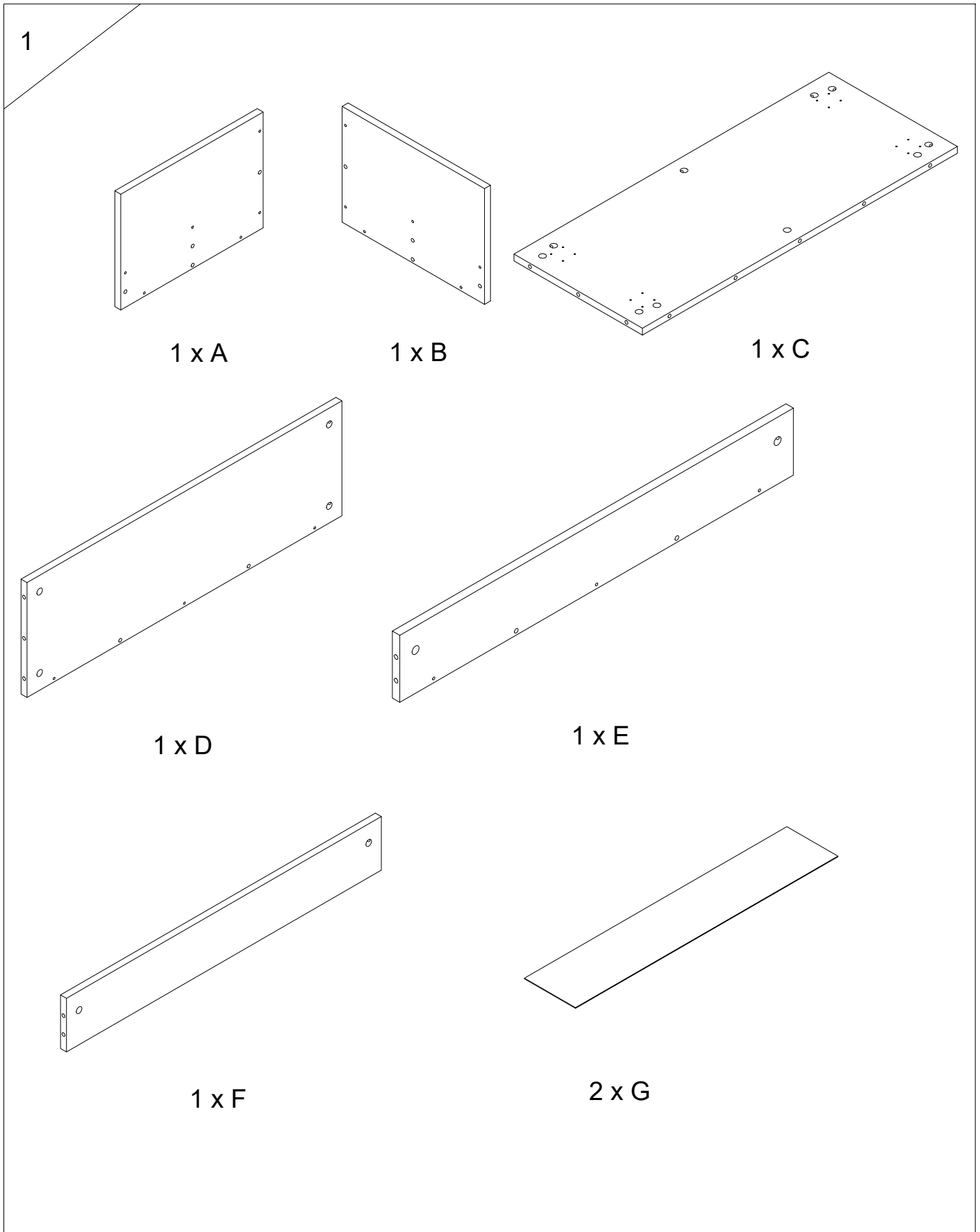

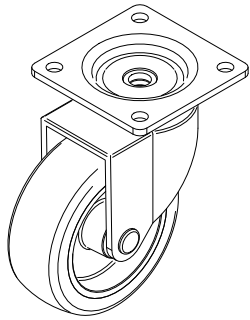

2



4 x H

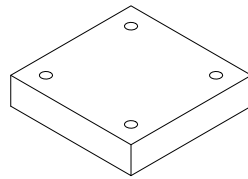

4 x I

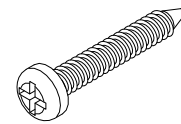

16 x J

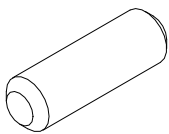

12 x K

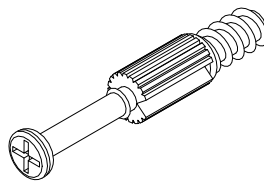

18 x L

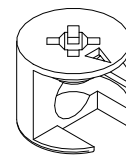

18 x M

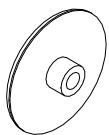

8 x N

