

Assembly Guide

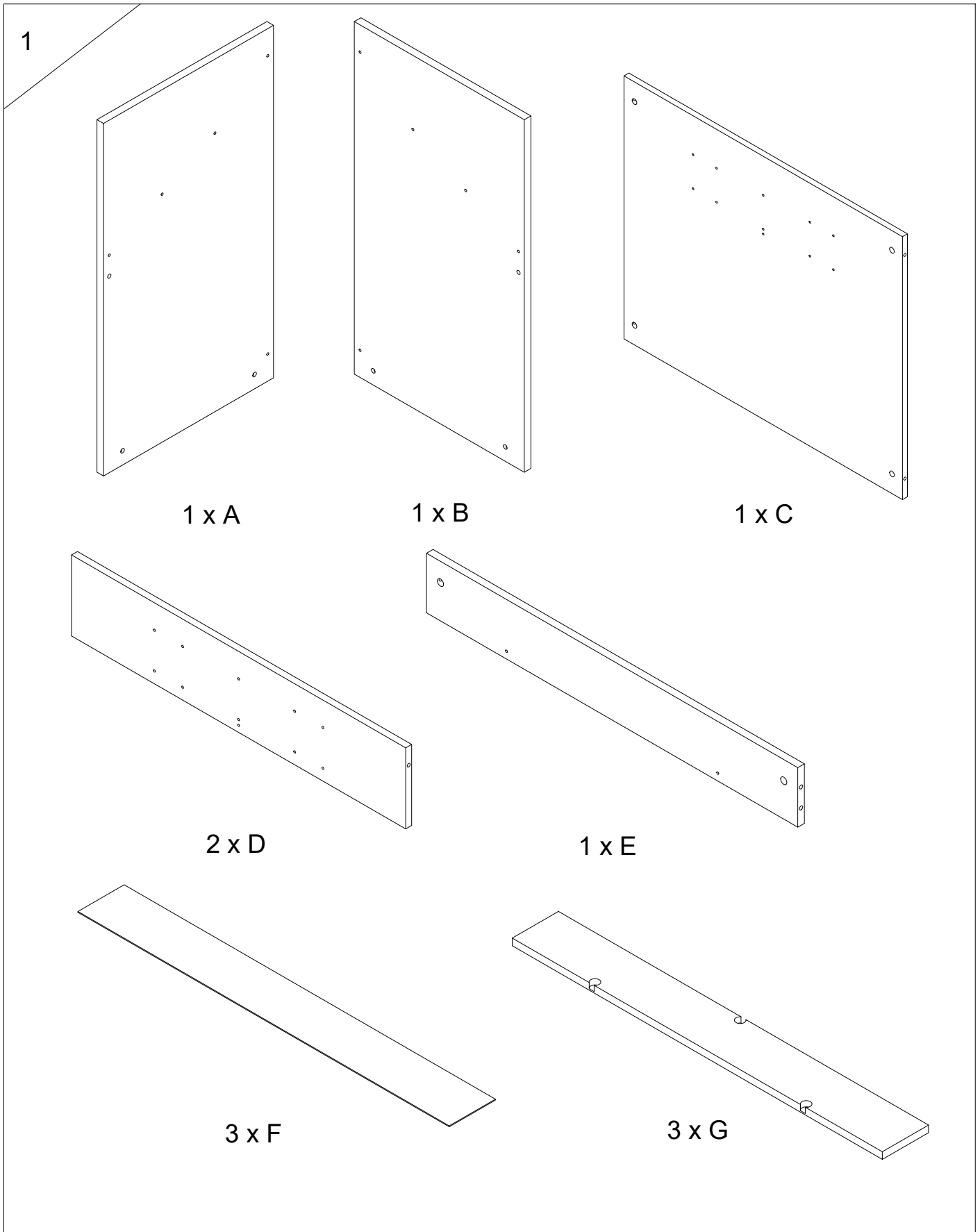

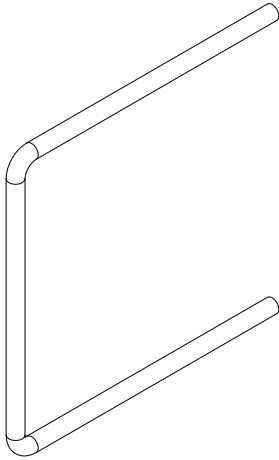

2



9 x H

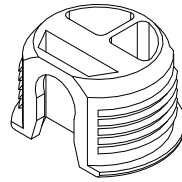

9 x I



9 x J

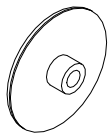

10 x K

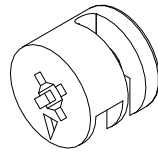

10 x L

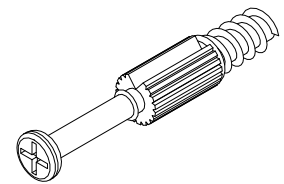

10 x M

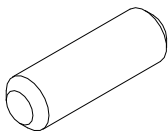

2 x N

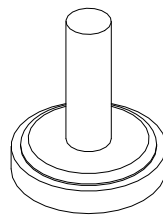

4 x O

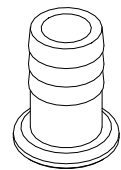

4 x P

